

Handbook for Sediment Quality Assessment

By Stuart L Simpson, Graeme E Batley, Anthony A Chariton,
Jenny L Stauber, Catherine K King, John C Chapman, Ross V Hyne,
Sharyn A Gale, Anthony C Roach, William A Maher



Handbook for Sediment Quality Assessment

**Stuart L Simpson¹, Graeme E Batley¹, Anthony A Chariton¹, Jenny L Stauber¹,
Catherine K King¹, John C Chapman², Ross V Hyne², Sharyn A Gale², Anthony C Roach²,
William A Maher³**

¹Centre for Environmental Contaminants Research, CSIRO Energy Technology, Bangor, NSW

²Centre for Ecotoxicology NSW Department of Environment and Conservation, Lidcombe, NSW

³Science and Design, University of Canberra, Belconnen, ACT



©CSIRO 2005

All rights reserved. Information in this publication is protected by the *Australian Copyright Act 1968* and subsequent amendments. Material from the publication may be used provided both the authors and the publisher are acknowledged.

ISBN 0 643 09197 1 (paper)

ISBN 0 643 09200 5 (PDF)

This publication can be cited as:

Simpson, SL, Batley, GE, Chariton, AA, Stauber, JL, King, CK, Chapman, JC, Hyne, RV, Gale, SA, Roach, AC and Maher, WA (2005). Handbook for Sediment Quality Assessment (CSIRO: Bangor, NSW)

Published by Centre for Environmental Contaminants Research

CSIRO Energy Technology
Lucas Heights NSW

Telephone: 02 9710 6807

Fax: 02 9710 6837

Email: stuart.simpson@csiro.au

Web site: <http://www.clw.csiro.au/cecr/sedimenthandbook>

Cover photo by Rob Jung, Centre for Environmental Contaminants Research, CSIRO Energy Technology.

Acknowledgements

This research was partially funded by a grant from the NSW Environmental Trust (Grant No. 2000/RD/G0003). The authors thank Peter Chapman for useful comments on this Handbook.

Disclaimer

Material presented in this document is the responsibility of the authors. The opinions expressed do not necessarily represent the views of CSIRO.

CSIRO accepts no liability (including liability in negligence) and takes no responsibility for any loss or damage which a user of this Handbook may suffer as a result of reliance on this document.

Cover design: Design ONE Solutions, Hall ACT

Typesetting: TechType, Giralang ACT

Printing: Bytes 'n Colours, Braddon ACT



EXECUTIVE SUMMARY

The last decade has seen an exponential growth in our understanding of contaminants in aquatic sediments. In Australia, as in many parts of the world, sediment quality guidelines have only recently been introduced, but detailed guidance on how to interpret and apply these guidelines is generally inadequate. It is recognised that there are a number of uncertainties in the science underpinning these guidelines that require additional research, and hence the Australian guidelines are termed 'interim'. The Australian approach was to introduce a tiered assessment framework so that exceedance of the interim guideline value led to additional studies to confirm or deny the possibility of biological impacts (ANZECC/ARMCANZ, 2000a; Environment Australia, 2002). This Handbook has been prepared in an attempt to summarise the latest science and provide information to guide future sediment quality assessment investigations.

The use of multiple lines of evidence consistent with the integrated assessment philosophy of the revised ANZECC/ARMCANZ (2000a) guidelines is currently the best approach to assessing sediment quality. This can be achieved by extending the current ANZECC/ARMCANZ decision framework to include bioaccumulation and ecological assessments, or by combining these and other lines of evidence (chemistry, toxicity) in a weight-of-evidence framework. Thus ideally investigations should combine assessments of:

- (i) sediment chemistry (e.g. exceedances of sediment quality guidelines), including contaminant bioavailability tests (e.g. porewater measurements, acid-volatile sulfide, biomimetic approaches for hydrophobic organic contaminants),
- (ii) toxicity testing (e.g. multiple species, varying exposure pathways, acute and chronic endpoints such as mortality, growth, reproduction, avoidance),

- (iii) bioaccumulation/biomagnification, and
- (iv) benthic community structure (e.g. ecological malfunction)

Toxicity identification evaluation and other causality considerations may also be of value. The combination and interaction between lines of evidence should be considered in applying these in a weight-of-evidence framework (e.g. particle size affects contaminant bioavailability; bioavailability test results will affect the interpretation of toxicity and bioaccumulation data). Weight-of-evidence assessments often ultimately rely on best professional judgment, but the use of tabular decision matrices is the best approach for achieving transparency and comprehension by lay personnel. This Handbook describes approaches for measuring the different lines of evidence, however new lines of evidence are continuing to be developed and future sediment quality assessments may incorporate these. While a general approach is proposed, assessments frequently need to be custom designed and lines of evidence chosen to suit the site-specific circumstances (e.g. site dynamics, sediment stability, groundwater flows, fluctuating overlying water conditions).

Environmental practitioners are seeking guidance on how to incorporate the latest science in their assessment of contaminated sediments, while relating their investigations to the sediment quality guidelines and the recommended guideline frameworks, at a time when the science is still being developed. This Handbook has been prepared in an attempt to summarise the latest science and provide information to guide future investigations. It incorporates the results of a recent NSW Environmental Trust project investigating sediment quality assessment protocols. The Handbook both reviews the existing literature and recommends how best to apply these

findings. Since the majority of Australia's sediment contamination concerns are with urban harbours that are estuarine and marine systems, the guidance in the Handbook is largely restricted to these systems. While

many of the principles will be equally applicable to freshwater systems, no guidance is provided in this document for freshwater toxicity tests or for ecological assessment procedures for freshwater environments.



TABLE OF CONTENTS

1	Introduction	1
1.1	Background	1
1.2	Sediment Quality Guidelines	2
1.3	Using Multiple Lines of Evidence	4
1.4	Using Both Tiered Assessment and WOE Frameworks	5
2	Sampling Design	7
2.1	Monitoring Programs and Sampling	7
2.2	Random Sampling	7
2.3	Targeted Sampling	8
3	Sediment Sampling	9
3.1	Collection of Sediments	9
3.1.1	Collection of surface sediments	9
3.1.2	Collection of sediment from depth	10
3.2	Field Records, Measurements and Observations	11
3.3	Field Processing, Transport and Storage	11
3.4	Sediment Manipulations Prior to Testing	13
3.4.1	Sieving	13
3.4.2	Collection of pore water from sediment	14
3.4.3	Preparation of sediment elutriates	15
3.4.4	Spiking of sediments	16
3.5	QA/QC Procedures for Sediment Collection and Manipulation	19
4	Chemical and Physical Characterisation of Sediments	20
4.1	Sediment Heterogeneity	20
4.2	General Sediment Quality Parameters	21
4.2.1	Sediment pH and redox potential	21
4.2.2	Water content	22
4.2.3	Particle size	22
4.2.4	Total organic carbon	22
4.2.5	Acid-volatile sulfides	23
4.3	Sediment Contaminants	24
4.3.1	Particulate metals and organometallics	24
4.3.2	Particulate organics	25
4.3.3	Contaminants in pore waters	26
4.4	Background/Reference Data	29
5	Sediment Ecotoxicology	30
5.1	Introduction	30

5.2	Selection of Organisms for Toxicity Tests	31
5.2.1	Contaminant exposure pathways	31
5.2.2	Porewater exposure	32
5.2.3	Toxicity modifying factors	32
5.3	Quality Assurance	33
5.3.1	Control sediments	33
5.3.2	Reference sediments	33
5.3.3	Reference toxicants	33
5.3.4	Test organism handling and acclimation	34
5.3.5	Criteria for test validity	34
5.4	Sediment Toxicity Tests	35
5.4.1	Selection of appropriate tests	35
5.4.2	Bacteria	36
5.4.3	Algae	37
5.4.4	Amphipods	38
5.4.5	Bivalves (clams)	39
5.4.6	Polychaete worms	40
5.5	Porewater and Elutriate Toxicity Tests	41
5.6	Overseas Test Species	41
5.7	Data Analysis and Interpretation	42
5.8	Toxicity Identification Evaluation (TIE) for Whole Sediments	43
5.9	<i>In situ</i> Testing	44
6	Bioaccumulation	46
6.1	Bioaccumulation of Metals	46
6.2	Bioaccumulation of Non-ionic (Hydrophobic) Organic Chemicals	47
6.2.1	Methods for assessing bioaccumulation of organic chemicals	47
6.2.2	Photo-induced toxicity from bioaccumulated PAHs	48
7	Ecological Assessment	50
7.1	<i>In situ</i> Benthic Community Assessment	50
7.2	Benthic Community Assessment as an Ecotoxicological Assessment Tool	50
7.2.1	Asking the right questions	51
7.3	Experimental Design and Sampling	52
7.4	Defining Benthic Communities, Taxonomic Resolution and Mesh Size	54
7.5	Collecting, Preservation and Sorting of Benthic Communities	55
7.5.1	Collection of samples	55
7.5.2	Fixing and preserving macrobenthic invertebrates	57
7.5.3	QA/QC	57
7.6	Identifying and Measuring Ecological Stress	58
7.6.1	Univariate measurements	58
7.6.2	Multivariate measurements	60

7.6.3	Graphical techniques	62
7.6.4	Linking benthic communities to environmental variables	65
7.7	Placing Benthic Community Studies in Context	66
8	Conclusions	68
9	References	69

Appendices

Appendix 1.	ANZECC/ARMCANZ Interim Sediment Quality Guidelines	80
Appendix 2.	Purge and Trap Method for Acid Volatile Sulfide (AVS) Analysis	81
Appendix 3.	Rapid Method for Acid Volatile Sulfide (AVS) Analysis	85
Appendix 4.	Protocol for Whole-sediment Toxicity Tests Using the Marine Microalga, <i>Entomoneis cf. punctulata</i>	87
Appendix 5.	Protocol for Whole-sediment Acute Amphipod Toxicity Tests Using <i>Melita plumulosa</i>	95
Appendix 6.	Protocol for Whole-sediment Acute Bivalve Toxicity Tests Using <i>Tellina deltoidalis</i>	102
Appendix 7.	Protocol for Whole-sediment Acute Polychaete Worm Toxicity Tests Using <i>Australonereis ehlersi</i>	108
Appendix 8.	Glossary of Terms and Acronyms	114

Figures

Figure 1.	ANZECC/ARMCANZ tiered framework (decision tree) for the assessment of contaminated sediments for (a) metals and (b) organics	3
Figure 2.	Species used for whole-sediment estuarine and marine toxicity testing	36
Figure 3.	A nested design that was randomly replicated on n sampling occasions. Locations were fixed, with sites randomly nested within the locations and times.	54
Figure 4.	A 100 mm diameter PVC core with a plastic ring attached to ensure that the core depth (100 mm in the above example) is consistent	56
Figure 5.	(a) No. of individuals, (b) Shannon-Weiner's index of diversity (H'), (c) taxa richness and (d) no. of polychaetes	59
Figure 6.	No. of (a) capitellid polychaetes, (b) crustaceans, (c) bivalves, and (d) gastropods	59
Figure 7.	A two-dimensional ordination map showing the relationship between replicates ($n = 4$) collected from four sites (stress = 0.13)	61
Figure 8.	K-dominance curves for Lake Macquarie sites	63
Figure 9.	Abundance biomass curves (ABC) for uncontaminated and contaminated locations	63
Figure 10.	NMDS ordination map	64
Figure 11.	An example of unimodal responses in the abundance of species A, B and C	66
Figure A1.	Flow cytometric histogram showing shifts in esterase activity (FL1 fluorescence versus cell count) of <i>E. cf. punctulata</i> after a 24-h exposure to copper	91

Tables

Table 1.	A tabular decision matrix for a semi-quantitative ranked assessment of contaminated urban harbour sediments	6
Table 2.	Explanation of ranking system used in Table 1	6
Table 3.	Summary of limits of determination (LOD) for analyses for common contaminants in sediments	25
Table 4.	Whole-sediment estuarine and marine toxicity tests	30
Table 5.	Toxicity tests for estuarine and marine sediment pore waters and elutriates	41
Table 6.	Statistical conditions and types of statistical errors formed from null hypotheses testing	52
Table 7.	Commonly-used levels of resolution for common taxonomic groups	55
Table A1.	Recommended sediment quality guidelines (ANZECC/ARMCANZ, 2000a)	80
Table A2.	Culture medium (f-medium) for <i>Entomoneis cf. punctulata</i>	90
Table A3.	Summary of toxicity test conditions for the <i>Entomoneis cf. punctulata</i> esterase inhibition test (whole sediment)	91
Table A4.	Summary of toxicity test conditions for the <i>Entomoneis cf. punctulata</i> esterase inhibition test (porewater test)	93
Table A5.	Summary of test conditions for the 10-d acute sediment toxicity test with the amphipod <i>Melita plumulosa</i>	98
Table A6.	Summary of test conditions for the 10-d acute sediment toxicity test with the bivalve <i>Tellina deltoidalis</i>	105
Table A7.	Summary of test conditions for the 10-d acute sediment toxicity test with the polychaete worm <i>Australonereis ehlersi</i>	111

Boxes

Box 1.	Impetus for the study in Lake Macquarie, NSW	51
Box 2.	Taxonomic resolution used in Lake Macquarie (2000)	55
Box 3.	Univariate measurements of the biota used in the analyses of benthic communities from Lake Macquarie	59
Box 4.	K-dominance curves from four locations within Lake Macquarie	63
Box 5.	NMDS ordination map of benthic assemblages collected in Lake Macquarie	64
Box 6.	The ten best combinations of variables produced from the BIOENV analysis from a survey study in Lake Macquarie (2000)	64



1 INTRODUCTION

1.1 Background

Since sediments are the ultimate repository of most of the contaminants that enter Australia's waterways, it is appropriate that regulatory attention address the ecological risks that these sediment contaminants might pose. There is an increasing public awareness and concern for the health of our waterways, and an expectation that water quality will be improved, but any improvement in water quality must address sediments as an important component of aquatic ecosystems, and a source of contaminants to the benthic food chain.

The sediments of many of the estuaries in New South Wales (NSW) have high metal loads, derived largely from past industrial discharges and urban drainage. In many instances there are also elevated concentrations of organic contaminants, especially polycyclic aromatic hydrocarbons (PAHs) and organochlorine (OC) pesticides. While the licensing of discharges has effectively controlled metal concentrations reaching surface waters from point sources, sediments remain a concern. In highly urbanised areas, urban drainage, including road runoff, continues to represent a major source of contaminants that ultimately accumulate in sediments. Rainfall events can also result in leaching of contaminated land sites, with contaminants reaching surface waters and groundwater, both of which can contribute ongoing contamination to sediments.

As part of the management of these sites, and prior to any remediation orders being placed on them, it is a requirement of the Contaminated Land Management Act that the 'significant risk of harm' from this potential pollution be assessed. This involves an assessment of the toxicity, persistence, bioaccumulation, and fate and transport of the contaminants present in the sediment. The

management/remediation of contaminated land and sediments is costly and these decisions need to be based on sound science.

The revised ANZECC/ARMCANZ *Guidelines for Fresh and Marine Water Quality* (ANZECC/ARMCANZ, 2000a; Batley et al., 2003) provided for the first time, a set of interim sediment quality guideline (SQG) trigger values (Appendix 1) that could form the basis of assessments of the risk that sediment contaminants might pose to the environment. These guidelines were derived from United States effects databases, and were termed 'interim' because deficiencies in their derivation were recognised, while the general understanding of the biological impacts of sediment contaminants and how best to regulate them was still being developed. In their current form, the interim guidelines recommend assessing sediment quality using chemical testing supplemented by toxicity testing, although the general integration of chemical and biological assessment is an underlying approach of the revised water quality guidelines. Few whole-sediment toxicity tests using Australian species were available when these guidelines were developed, and, for those tests that existed, data interpretation has been hampered by a poor knowledge of species sensitivity to contaminants (Batley et al., 2005) and their exposure pathways (Simpson and King, 2005). Uncertainties remain regarding the capacity of laboratory-based toxicity tests to predict wider ecological effects. The tiered assessment framework of the guidelines does not involve the assessment of benthic ecology or bioaccumulation (ANZECC/ARMCANZ, 2000a), which are recognised as important indicators of sediment quality. The integration of these with evidence from environmental chemistry and ecotoxicology was recommended in a revised tiered framework (decision tree) proposed by Batley (2001).

In 2001, CSIRO, in collaboration with the University of Canberra and the NSW EPA (now the Department of Environment and Conservation), commenced a 3-year project, funded by the NSW Environmental Trust, to develop protocols for assessing the risks posed by metal-contaminated sediments in NSW. This study developed sensitive new sediment toxicity tests, examined metal uptake pathways for sediment-dwelling organisms and characterised metal effects on sediment communities. The information gained in these studies and related research conducted by the team, has been integrated with the latest international research in this Handbook, to provide a more sound basis for sediment quality assessment.

This Handbook discusses the approaches and methods that are recommended for sediment quality assessments that build on the ANZECC/ARMCANZ tiered assessment and the integrated assessment philosophy. These involve the use of multiple lines of evidence (LOE), and considerations of how these can be integrated in weight-of-evidence (WOE) frameworks to be used in decision-making. The Handbook summarises the latest science, and provides information to guide future investigations. Since the majority of Australia's sediment contamination concerns are with urban harbours that are estuarine and marine systems, guidance is largely restricted to these systems. While many of the principles will be equally applicable to freshwater systems, no guidance is provided for toxicity test and ecological assessment procedures for freshwater environments.

1.2 Sediment Quality Guidelines

At the time of their preparation, the Australian and New Zealand SQGs represented the latest in international thinking (ANZECC/ARMCANZ, 2000a). Empirical SQGs had already been adopted in Canada, Hong Kong, and in several states of the USA, and were also being considered in Europe. In Australia and New Zealand, the guidelines were termed 'interim' in recognition that this was a first stage in the process. Further, unlike their use elsewhere, they were to be used as part of a tiered

assessment framework (Figure 1), in keeping with the risk-based approach introduced in the water quality guidelines. The SQG values are trigger values that if exceeded are the prompt for further investigations to determine whether there is indeed an environmental risk associated with the exceedance.

Recent research has provided an improved understanding of the science underpinning SQGs. These have been thoroughly documented in the proceedings of a recent international workshop on the subject (Wenning et al., 2005). In particular, the limitations and uncertainties of current approaches need to be fully appreciated by the users, and these are discussed in detail in a number of recent publications (Simpson and Batley, 2003; Batley et al., 2002, 2005). SQGs for metals in use worldwide vary over several orders of magnitude and are not based on clear cause-effect relationships (Chapman et al., 1999; Borgmann, 2003; Simpson and King, 2005).

Basically there have been two approaches to SQG derivation, (i) empirically-based and (ii) mechanistic approaches that are based on equilibrium partitioning (EqP) theory. The various versions of both approaches frequently converge in the prediction of effects on benthic organisms. In short, the science is able to define reasonably well the concentration ranges below which no effects are observed and above which effects are almost always observed. It is in the intermediate 'transition zone' that the predictions become poor, in some cases by as much as an order of magnitude based on EqP predictions.

The empirical guidelines were derived from a ranking of toxicity and other effects data using a large North American database. Because contaminants typically co-occur (e.g. metals and organics), any toxicity was equally attributed to all components of the mixture. In instances where only one class of contaminants occurs at a concentration that causes effects, other contaminants that are present, albeit at very low concentrations, are considered equally as the cause of the toxicity, and as a consequence their derived guideline can become too conservative. For example, toxicity may be due to PAHs (which are high in

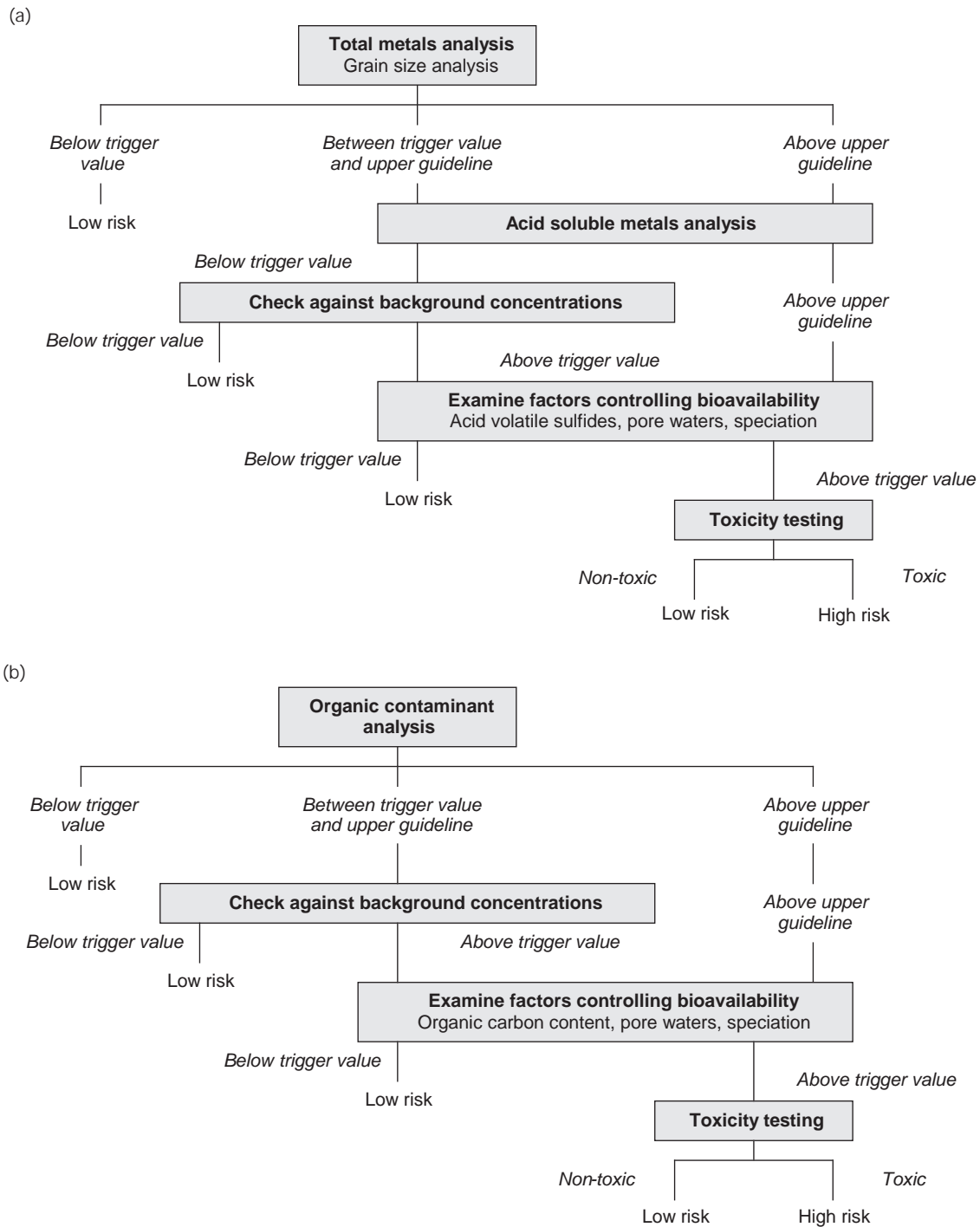

Figure 1. ANZECC/ARMCANZ tiered framework (decision tree) for the assessment of contaminated sediments for (a) metals and (b) organics

the sediments) but toxicity is equally ascribed to zinc (as it is present, but not necessarily causing any effects), so that the zinc guideline is too conservative (overprotective).

The Australian and New Zealand interim sediment quality guidelines (ISQGs) use the empirical guidelines derived from the North American effects database (ANZECC/ARMCANZ, 2000a). They are not based on cause-effect relationships, unlike the Australian and New Zealand water quality guidelines (WQG). This has sometimes caused confusion and misinterpretation of the ecotoxicological significance of the sediment chemistry data. The guidelines contain two concentrations, the ISQG-Low concentration (or trigger value) and the ISQG-High concentration. The trigger value is a threshold concentration, and below this concentration the frequency of adverse biological effects is expected to be very low. The ISQG-High concentration is intended to represent a concentration, above which adverse biological effects are expected to occur more frequently.

Exceeding the trigger value concentrations does not necessarily mean that adverse biological effects will occur in the sediments, but further investigations should be undertaken to confirm this, following the site-specific, tiered assessment frameworks shown in Figure 1.

1.3 Using Multiple Lines of Evidence

The need for improved frameworks that include multiple LOEs has been highlighted at several recent workshops (Burton et al., 2002; Chapman et al., 2002a; Wenning et al., 2005). Their value is when combined in WOE assessments. Burton et al. (2002) suggested the consideration of six main LOEs in sediment quality assessments:

- (i) Are contaminants present at levels of concern? (sediment chemistry)
- (ii) Are the contaminants capable of causing toxicity? (assessment of bioavailability, laboratory toxicity tests, knowledge of species sensitivity)

- (iii) Are resident biotic communities altered? (community structure analyses)
- (iv) Are the contaminants causing the observed toxicity and/or community alterations (cause-effect directed manipulative experiments, e.g. toxicity identification evaluation (TIE))
- (v) Are any contaminants of concern capable of and likely to biomagnify? (sediment chemistry and biota tissue analyses, food chain modelling)
- (vi) Is the sediment stable or is it liable to erosion resulting in exposure of deeper more contaminated sediments and/or contamination down-current? (shear stress and cohesion measurements, analysis of deeper sediments)

The types of LOE will include those that form parts of the ANZECC/ARMCANZ tiered assessment framework (Figure 1), namely sediment chemistry (e.g. exceedances of SQGs), contaminant bioavailability tests (e.g. porewater measurements, acid-volatile sulfide (AVS), biomimetic approaches for hydrophobic organic contaminants), and toxicity testing. Additional LOEs may include bioaccumulation/biomagnification, benthic community structure (e.g. ecological malfunction), toxicity identification evaluation (TIE) and other causality considerations. Approaches for measuring various LOEs are discussed below. Many new LOEs are continuing to be developed for sediment quality assessment purposes. There is no single multiple LOE approach for sediment quality assessments and studies should be custom designed and LOEs chosen to suit the site-specific circumstances (e.g. site dynamics, sediment stability, groundwater flows, fluctuating overlying water conditions). Field-based (*in situ*) testing may be applicable for some assessments.

Each LOE needs to be analysed appropriately so that the findings can be reasonably interpreted. Along with the six considerations listed above, the ecological relevance of all LOEs needs to be addressed. Suter (1993) suggested the following criteria as part of an

assessment of the strength of evidence:

- (i) the adverse effect should be regularly associated with exposure to the stressor,
- (ii) the stressor (or indicator of exposure) should be found in the affected receptor (organism, population, community),
- (iii) the adverse effect should be manifest in unimpaired species following exposure under controlled experimental conditions,
- (iv) the stressor should be found in the experimentally-affected species.

Approaches to the more complete integration of multiple LOEs into a weight of evidence (WOE) evaluation have been comprehensively reviewed in a series of papers introduced by Chapman et al. (2002a). These approaches comprise three basic types:

- (i) qualitative methods based on best professional judgement,
- (ii) semi-quantitative approaches using rankings or scoring systems, or
- (iii) quantitative methods using probability or multivariate approaches.

The use of best professional judgement has been recommended over other ranking or statistical approaches, especially where there are uncertainties and few data, that are otherwise inconclusive (Johnson, 1999; Ellis et al., 2002). In all WOE interpretations, it could be argued that there is at least some application of best professional judgement.

The semi-quantitative approaches convert LOE data into tabular form. Menzie et al. (1996) advocated a consensus-based approach as part of a risk assessment framework. Assessment endpoints were based on weight, magnitude and concurrence, with 10 separate judging attributes weighted by stakeholders based on best professional judgement. They comprised: degree of association, stressor/response, utility of measure, data quality, site specificity, sensitivity, spatial representativeness, temporal representativeness, quantitative measure, and standard measure.

The use of scoring systems has been discussed by Chapman (1990, 1996), USEPA (2000a) and Grapentine et al. (2002). The original sediment quality triad (SQT) approach of Chapman (1990) has now been significantly improved, while retaining the tabular decision matrix. Improvements by Grapentine et al. (2002) advocated a pass (-) or fail (+) approach to each LOE, based on a ranking (score of 1 to 4) within each LOE.

The SQT approach recommends using no more than three scores, equivalent to high, medium and low, and this appears to be a useful concept for sediment quality assessment. A typical example of an effective scoring (logic system), described by Chapman et al. (2002a) for an urban, marine sediment, is shown in Table 1. The ranking system used in this Table is defined in Table 2. Other examples are presented in the original reference.

The more detailed quantitative approaches are described in papers by Reynoldson et al. (2002), Bailer et al. (2002) and Smith et al. (2002). These are better suited to very large datasets, with large numbers of reference sites. They require an expert statistician as part of the project team.

The following pages present details of how to obtain the necessary data for each LOE discussed above.

1.4 Using Both Tiered Assessment and WOE Frameworks

Some confusion may arise whether to use the ANZECC/ARMCANZ tiered assessment (decision tree) or WOE frameworks for the assessment of contaminated sediments. Recent applications of the ANZECC/ARMCANZ framework have demonstrated the need, when SQGs are exceeded based on bioavailable contaminant assessment, to go beyond the next tier assessment of toxicity to demonstrate whether or not there are detrimental effects on ecosystem health. This is usually because of difficulties in demonstrating cause and effect relationships in toxicity testing, or because of the lack of appropriate tests that respond near the SQGs for particular contaminants. Equally

there is the issue of whether the SQGs are reliable or artifactually conservative. The extension of the tiered assessment to include LOEs such as contaminant bioaccumulation and benthic ecology is therefore logical, as is the assessment of the multiple LOEs in a WOE framework.

The WOE framework extends and transforms the tiered approach to encompass and rank (tabular decision matrix) to all available LOEs in a manner that is transparent and easy to comprehend by lay personnel.

Table 1. A tabular decision matrix for a semi-quantitative ranked assessment of contaminated urban harbour sediments

Site	Sediment Chemistry PAH-PCB-metal	Porewater Chemistry, TBT	AVS/ SEM	10-d Amphipod Survival - Avoidance	48-h Bivalve-Larvae Survival	20-d Polychaete Survival - Growth	Benthic Community Structure Abundance-diversity	Overall Assessment ^a	
								Abs. risk	Rel. risk
Near-field sites									
1	2-1-2	1	2	2-1	1-1	1-2	3-3	3	3
2	1-1-3	1	1	1-1	2-3	1-1	ND	2	2
3	3-1-2	1	1	1-1	3-2	1-2	2-1	3	3
4	2-1-2	1	1	2-1	1-3	1-2	2-1	3	3
5	2-2-2	1	1	1-1	3-3	1-1	2-1	2	2
6	2-1-2	1	1	1-1	1-1	1-1	3-1	2	1
Far-field sites									
7	2-1-2	1	1	1-1	1-1	1-1	2-2	2	NA
8	1-1-2	ND	1	2-1	1-1	1-1	3-1	2	NA
9	2-1-2	1	1	1-1	1-1	1-1	1-1	1	NA

^aAbsolute risk is the WOE for various lines of evidence without consideration of far-field background responses (i.e. comparison to negative controls). Relative risk is the absolute risk normalised to the mean response observed at far-field locations.

Table 2. Explanation of ranking system used in Table 1

Parameter	Ranking		
	3	2	1
Sediment chemistry - PAH, PCB, metals	One or more analytes in a given category >-5 x SQG	One or more analytes in a given category <5 x SQG	No analytes exceed SQG
Porewater TBT	>-5 x WQG	<5 x WQG	<WQG
Toxicity (endpoint relative to negative control)	Reduction >50%	Reduction >20%	Reduction <20%
Benthos (relative to harbour wide background)	Abundance and/or diversity substantially lower	Abundance and/or diversity slightly lower	Abundance and/or diversity not lower
Overall assessment	Significant adverse effects predicted due to: elevated chemistry, >20% reduction in two or more toxicological endpoints, and reduced benthic diversity or abundance	Potential adverse effects predicted due to: elevated chemistry, >20% reduction in two or more toxicological endpoints, or reduced benthic diversity or abundance	No significant adverse effects predicted due to: elevated chemistry, no reduction in re toxicological endpoints, and no reduced benthic diversity or abundance



2 SAMPLING DESIGN

2.1 Monitoring Programs and Sampling

Sampling design should be considered in the context of an overall monitoring program and its overall objectives. As an initial step, as recommended in the *Australian and New Zealand Guidelines for Water Quality Monitoring and Reporting* (ANZECC/ARMCANZ, 2000b), the objectives of the monitoring program need to be set. This process involves defining the issue, defining the information requirements, collating available information, and then developing some preliminary system understanding, usually in the form of a conceptual process model.

In many cases, sediment investigations are descriptive studies, simply designed to investigate the spatial and temporal distribution of contaminants, for state of the environment reporting, for compliance monitoring, or to guide management actions, e.g. dredging. In rarer instances, the objective may be to examine contaminant transport and depositional processes. In most instances the assessment objectives are likely to be driven by regulatory requirements, and evaluation of the potential impacts on ecosystem or human health.

The design of a sampling program for sediments must take into account the fact that sediments are quite heterogeneous, both chemically and physically. Contaminant distribution will be very much grain size dependent. In general, contaminants that accumulate via adsorption to particles will be associated with the finest, high surface area particles. Sandy and other coarse grain sediment particles will generally have low contaminant content and will generally pose a low threat to benthic organisms.

The frequency of sampling undertaken in monitoring studies may also be dictated by the rate of sedimentation. Sedimentation rates in water bodies typically vary from mm to 1-2 cm/year, although in tropical areas with

large seasonal variability in river flows, sediment accumulation in off-river areas can be much larger. Except in the latter cases, recent sedimentation is therefore unlikely to be seen at depths below 5 cm.

The distribution of biological activity in sediments will also be quite variable. Biota use the sediment variously as a refuge, a habitat and a food source. For burrowers, for example, the acceptability of the sediment particle size for burrowing might determine their distribution, while for microorganisms the availability of nutrient sources might be critical. The bulk of biological activity also occurs in the upper 10 cm, although some organisms can burrow to greater depths. The depths to which sediments are sampled should therefore be relevant to the monitoring objective. At some stage, it may be appropriate in any monitoring survey to establish the nature of the depth profile of contaminants at the sites under consideration. If the objective is to look at the totality of the impact of sediments on biota in the top 2 or 10 cm, then if the sedimentation rate is below 1 cm/year, it will be difficult to detect significant change by annual monitoring and measurements every 2-3 years might be more appropriate, or otherwise only the uppermost (0-2 cm) sediment layer should be considered.

The size of the study area will greatly influence the type of sampling design and site positioning methods that are appropriate. Random or targeted sampling designs may be used.

2.2 Random Sampling

Random sampling involves the selection of sites randomly in order to provide an unbiased assessment of the condition of the sediments within a water body. The use of random sampling designs has a greater ability to miss key sites that are necessary to develop relationships among variables, e.g. estimation

of benthic response or contaminant concentration, in relation to a known contaminant discharge point. Random selection of stations may not include a sufficient number of key sites as many sites will be well removed from the contaminant source.

To overcome these problems with random sampling designs, random stratified designs are preferred, with sampling locations at increasing distances from the point source, in the case of a discharge. The spatial heterogeneity (both horizontal and vertical) must be taken into consideration. Sampling should involve replicate samples to determine localised heterogeneity. Vertical heterogeneity can be readily assessed from core samples and, for this purpose, they are preferable to surface grab samples. Sediment deposition in a water body will not necessarily occur uniformly, but will be dictated by flow. Scouring of bottom

sediments is common in the channels of fast flowing rivers, while deposition will occur in low flow regions.

2.3 Targeted Sampling

Targeted sampling requires existing information, and the selection of sites based on this knowledge. In targeted sampling designs, sites are selected based on prior knowledge of other factors, such as contaminant sources, substrate types, water depths, tidal influences, and anthropogenic activities. Targeted sampling designs can often be quickly implemented and offer much more flexibility than statistically-based (random) sampling designs. Data from targeted sampling cannot, however, be easily used to make predictions of contamination at other sites (stratified random sampling is better for this purpose).



3 SEDIMENT SAMPLING

3.1 Collection of Sediments

For the assessment of sediment quality, surface sediments are more commonly collected. However, when evaluating the risks of dredging activities to determine their suitability for ocean disposal, deeper sediments may also require collection. Generally, most epifaunal and infaunal organisms are found in the upper 10 cm of sediments. Some epibenthic species (e.g. shrimps, certain amphipods) might only be exposed to surficial sediments (0-1 cm) while others (e.g. bivalves, polychaetes) that are infaunal irrigators might receive their primary exposure from sediments that are several cm in depth. Determining contaminant concentrations in both the 0-2 and 2-10 cm depth sediments should provide sufficient information to assess major contaminant exposure pathways for most organisms.

A large range of devices is available for the collection of sediments and reviews of their uses and suitability for different collection conditions are available (Mudroch and Azcue, 1995; USEPA, 2001). The most important requirement for sediment collection devices is that the integrity of the collected sediment is maintained, because disruption of the sediment's structure will distort its chemical and physical characteristics. For example, this could involve mixing of previously redox-stratified chemical substrates with layers of differing particle size and composition, thereby influencing the bioavailability of contaminants and the potential toxicity of the sediment (Simpson and Batley, 2003).

The quantities of sediments that require collection will depend on the analyses and tests to be undertaken. Generally, 2 kg of sediment from each site should be sufficient for analyses of most contaminants (e.g. 1 kg for elutriate tests, 250 g for organics, 50 g for each of metals, AVS, analysis of particle size and other physical properties), and for toxicity tests (3× 50-100 g/species). All samples should

be stored using techniques appropriate for the desired analysis (e.g. glass jars for organics, sediments frozen for AVS) (Section 4).

Sample containers and sampling devices should be cleaned thoroughly before use by soaking in 10% nitric acid (for metals) or rinsing with acetone for organics (ASTM, 2000a; USEPA, 2001). Before sample retrieval, and between each sampling event, the outside of the sampling device should be rinsed clean with water from the sampling station. For some assessments, more rigorous between-sample cleaning of the sampler might be required (e.g. washing with detergent to remove oil films, then further rinsing to remove excess detergent).

When sampling sediments of unknown composition, ASTM (2000a) recommends that samplers and containers be subject to (i) a soap and water wash, (ii) a distilled water rinse, (iii) an acetone or ethanol rinse, and, (iv) a site-water rinse. Where the test sediments are expected to be very contaminated, cross-contamination to reference sites should be minimised by sampling these latter sites first.

It is important to check the sample integrity before accepting the collected sample for subsequent physical, biological, chemical, or toxicity testing. Grab samples are acceptable if the surface layer appears to be undisturbed (sediment-water interface is intact and relatively flat, with no sign of channelling or loss of fine materials), and if the volume of sediment is sufficient. Core samples are acceptable if the core was inserted vertically in the sediment and an adequate depth was sampled. Repeated sampling may be required to obtain the desired quantity of material from both grab and core samples.

3.1.1 Collection of surface sediments

The surface layer provides information on the most recently deposited sediment materials

and should be used to determine the horizontal variation in sediment properties and the distribution of contaminants. Knowledge of the bathymetry and distribution of physically different sediment types and habitats (e.g. seagrass areas) may aid selection of sampling sites.

Grab samplers should be used to collect surface sediments due to their ease of handling and operation and their versatility for collecting a range of sediment substrates. The Birge-Ekman sampler is suitable for sampling soft sediments in shallow, quiescent water, and small or lightweight designs may be operated by hand line while wading or from a boat. The Van Veen grab sampler is more versatile for collecting sediments with a range of sediment properties, and is generally operated by winch from a boat. Importantly, the grab sampler should protect the sample from disturbance, minimise washout of fine-grained sediments and allow easy access to the surface layer by lifting of movable cover flaps. Both the Birge-Ekman and Van Veen samplers permit relatively non-disruptive sampling. During deployment of a grab sampler, the speed of descent should be controlled, with no 'free fall', so that a bow wave is not created that mixes or disperses the surface layer upon impact. Birge-Ekman samplers are not recommended for use in strong currents or high waves and may be less stable during sediment penetration. A discussion of these and other grab samplers (e.g. Ponar, Petersen, Shipek, Smith-McIntyre) is available elsewhere (Mudroch and Azcue, 1995; USEPA, 2001). Grab samplers are preferred for the collection of all submerged surface sediment samples. If sediments are collected from areas exposed at low tide, a shovel or other hand implement may be appropriate.

3.1.2 Collection of sediment from depth

Sediments from depths greater than 15 cm should be collected to determine the spatial (vertical and horizontal) variation in sediment properties and the distribution of contaminants. This is often useful for 3-dimensional mapping of contaminants for defining volumes of contaminated sediment for

dredging. Core samplers should be used when assessments require (i) accurate surficial sediment depth resolution, (ii) detailed vertical profiles of sediment properties, contaminants or sedimentation history, and (iii) where it is important to maintain an oxygen-free environment (ASTM, 2000b).

Hand corers (<1 m sediment depth) can be used by wading in shallow waters or by divers. Vibrocorers yield excellent sample integrity and are recommended for the collection of deep cores (up to 6 m), or where sediment consists of very compacted or large-grained material (e.g. gravel). Box corers (<1 m depth) are particularly useful for (i) collecting larger volumes of sediment from a given depth (allows sediment for all tests to be collected from one sample) and (ii) for collection of sediments for porewater water extraction and characterisation. The Phleger, Alpine, and Kajak-Brinkhurst corers may be more versatile for routine monitoring. A discussion of operation of these and other core samplers (e.g. Alpine, Box, Gravity, Kajak-Brinkhurst, Phleger, Piston) is available elsewhere (Mudroch and Azcue, 1995; USEPA, 2001).

Hand corers are typically 60 cm × 5-10 cm diameter and made from Perspex or polycarbonate, desirably with a bevelled leading edge. These are immersed by divers in deep waters or by wading in shallower waters. After immersion, the tubes are capped with tight fitting polyethylene (or other appropriately non-contaminating) caps, then are withdrawn and the bottom similarly capped. In water of less than a few metres depth, PVC core tubes up to 4 m in length can be immersed from a boat, and sectioned on shore to recover only the sampled depth (<1 m). Perspex corer tube designs with extendable aluminium pole sections can also be constructed for use from a boat in shallow depths, but they are designed so that the cores can be extruded immediately following collection usually using a nitrogen or similar gas stream from a portable cylinder.

Where measurement of fluxes of contaminants from sediments is an objective, 40 cm × 15 cm diameter Perspex corer-reactors are ideal (Jung et al., 2003). Here the corer, containing

collected sediment, becomes a laboratory reactor with the addition of site water and a reactor head, comprising stirrer, gas bubbler and sampling ports.

Wider diameter cores (e.g. >7 cm) should be used to reduce the friction of clayey sediments within the core tube, allowing the sediment to pass more freely and resulting in less compressed core samples (more accurate depth information). Care should be taken to keep the core upright and stationary during transport to the water surface and prior to sectioning. The entire space over the sediment in the core tube should be filled with site water, and both ends of the core tube capped and taped to prevent mixing of the sediment inside. If sediment oxidation is a concern (e.g. changes in metal bioavailability or volatile substances), then the headspace of the core tube should be purged with an inert gas such as nitrogen or argon. Repetitive sampling of cores may be required to obtain the desired quantity of material from a given depth.

3.2 Field Records, Measurements and Observations

Field measurements and observations are important for any assessment of sediment quality. Field records should include site identifier (name or number), site location (recorded by GPS), time and date of sample collection, sample identifier (number or name) and replicate number. Measurements should include (i) water quality parameters (pH, redox potential, dissolved oxygen, temperature, conductivity/salinity, turbidity and water depth) in the water column 5-20 cm above the sampling site, and (ii) pH and redox potential of the surface sediments and depth sediments if sectioned from cores in the field. Observations should include (i) water column conditions during sampling (tides, waves, clarity), (ii) sediment properties (gravel, sand, silty-sand, silt), the occurrence of debris (wood, shells, and other debris) and plants (e.g. seagrass) and the sediment depth sampled. Collected cores should be photographed, visually examined and changes in strata with depth recorded (texture and consistency, colour, presence of biota or

debris, evidence of oil). If the sediment colour changes from brown to black down the sediment core, the depth and thickness of this layer should be recorded (evidence of redox conditions). Chain-of-custody forms should be prepared that identify each sample collected and the analyses to be conducted on the sample.

3.3 Field Processing, Transport and Storage

Any form of disturbance to the sediments, whether through the act of sampling, field processing or transportation, will affect the bioavailability of the contaminants (Thomson et al., 1980; Bull and Williams, 2002; Langezaal et al., 2003; Simpson and Batley, 2003; Simpson et al., 2004). Although disturbances to the sediments cannot be eliminated, it is important that they are minimised. Following collection, sediment samples should be stored cold (on ice) to reduce loss of volatiles and decrease bacterial activity. Field processing, or manipulation, of sediments may result in changes in the speciation, and bioavailability, of substances by disruption of the equilibrium in the porewater/sediment system. For example, sediment mixing or sub-sampling may cause intrusion of air into sediments and the oxidation of sensitive substances, changes in oxidation state of previously redox-stratified sediment components (Fe(II)/Fe(OH)₃/FeS) and the subsequent reactions of these new phases, and changes to the availability of organic compounds due to the disruption of equilibrium with organic carbon in the porewater/sediment system. If sediment oxidation is a concern (e.g. oxidation of iron(II) and AVS will affect metal bioavailability), then the headspace above the sample should be purged with an inert gas (such as nitrogen or argon), or the entire sample stored in an inert gas atmosphere. Filling containers completely will minimise the immediate interaction of samples with air.

Sediment samples to be analysed for metals or inorganic contaminants should be stored in plastic materials; high-density polyethylene (HDPE) or polytetrafluoroethylene (PTFE)

containers are most suitable. Samples for organic contaminant analysis should be stored in borosilicate glass containers with PTFE lid liners (preferably brown glass for photoreactive compounds such as PAHs). These materials will minimise leaching, dissolution, and sorption (ASTM, 2000a). Sub-samples should be collected away from the sides of the collection apparatus to avoid potential contamination. All utensils (e.g. spoons, scoops, spatulas) that come in direct contact with sediment samples during handling and processing should be made of non-contaminating materials (e.g. HDPE or PTFE for samples for metals analyses and high-quality stainless steel for samples for organics analyses). All equipment and containers used to sub-sample and store sediments should be cleaned using appropriate techniques (ASTM, 2000a).

Before sub-sampling from a grab sampler, the overlying water should be removed by slow siphoning using a clean tube near one side of the sampler. For sediment cores, the choice of depth horizon(s) and the techniques for sectioning of the core will depend on the study objectives as well as the nature of the substrate. Sectioning can be undertaken either by splitting the core tube longitudinally, or by extrusion through the application of upward pressure on the sediment from the base (e.g. using a Perspex piston designed to fit snugly in the core tube). The exposed sediment should be immediately cut into sections of the desired thickness using a stainless steel or plastic (HDPE or PTFE) cutter. The outer layer of sediment that has been in contact with the cutting blade and the core tube (1-2 mm) may need to be removed and discarded due to contamination before transferring to the storage container. Further discussion of techniques for sectioning cores is available elsewhere (Environment Canada, 1994; Mudroch and Azcue, 1995; USEPA, 2001). Depending on the tests to be made on the collected sediment, the sediment within the core may need to be extruded, and processed, under oxygen-free conditions (Simpson and Batley, 2003).

Sub-sampling is not easily done in the field, in which case cores should be chilled (on ice) or

frozen, depending on the measurements to be undertaken. In either case, cores should be stored vertically and undue agitation during transportation avoided, as this will particularly mix the surface layers in unfrozen cores. Freezing has been found to rupture bacterial cells and release accumulated elements, such as selenium, into pore waters (Jung and Batley, 2004). Freezing of sediments is recommended if either AVS or total contaminant analyses are required.

Maximum holding times are governed by sediment type, contaminant characteristics and the tests to be undertaken on the sediments. The general recommendation is to store sediments and pore water in the dark at 4°C (Carr and Nipper, 2003; Geffard et al., 2004). Sample holding times and storage methods will vary depending on the use of the collected sediments or sediment components (e.g. pore waters). Samples for analyses of total metals may be held indefinitely, but changes to metal speciation and partitioning of contaminants between sediments and pore waters will begin occurring within days of collection (Carr and Chapman, 1995; Defoe and Ankley, 1998; Cole et al., 2000; Simpson and Batley, 2003). Changes in bacterial activity will cause changes to the concentrations of ammonia, sulfide, iron(II) and biologically-active sediment components, particularly in pore waters. It is generally recommended that if pore waters are of interest, they should be extracted immediately after collection and appropriate preservation procedures and storage containers used for each analyte (may need separate containers). Most extractable organics (e.g. phthalates, OC pesticides, polychlorinated biphenyls (PCBs), PAHs, hydrocarbons, dioxins) should be extracted from sediments within 14 days of sample collection, while 7 days should be the maximum storage length before extraction of samples for analyses of organic contaminants that are susceptible to losses due to volatility or microbial degradation. Storage containers for samples for analyses of organics (sediments or water extracts) should be glass and plastic lids should be PTFE-lined to minimise adsorptive losses.

Sediments for use in toxicity tests should be tested as soon as possible after collection, but this time will often be determined by the time required for chemical analyses. It is suggested that sediments should be stored for no longer than 8 weeks before toxicity testing (USEPA/USACE, 1998; Geffard et al., 2004). Longer storage times may be appropriate depending on properties of the sediments, the concentrations and types of contaminants. Extended storage of sediments may result in (i) losses of labile or volatile contaminants (e.g. ammonia, volatile organics, AVS) or (ii) changes to the redox properties of the sediments due to increased or decreased bacterial activity (Simpson and Batley, 2003). Either of these processes may result in major changes to the concentrations or bioavailability of the sediment contaminants. For sediments stored for long durations (e.g. greater than 8 weeks), re-analysis of some contaminant concentrations may be required before testing.

3.4 Sediment Manipulations Prior to Testing

Manipulation of sediments in the field or laboratory is often undertaken prior to chemical or toxicity testing. This may involve sieving to remove large particles and debris, or the separation of native biota, or homogenisation so that a large sample can be used for a number of chemical and biological tests (e.g. Bufflap and Allen, 1995; Carr and Chapman, 1995; Sarda and Burton, 1995; Burgess and McKinney, 1997; Sijm et al., 1997; Chapman et al., 2002b; Simpson and Batley, 2003; Fisher et al., 2004). Most manipulations of sediments will alter the properties of the sediments and affect contaminant bioavailability, and the effects of these on the test data need to be evaluated. All procedures used to prepare sediment samples for analyses and tests should aim to minimise disturbances and should be fully documented in reports.

It is desirable to undertake some assessment of how sample manipulation may affect the concentrations (e.g. loss of volatiles), bioavailability (e.g. changes to AVS, partitioning in pore waters) and toxicity of

contaminants in the collected sediments. For the freshly collected whole-sediments that have been minimally manipulated, measurements of pH, redox potential, TOC, AVS, iron, particle size analysis, and analyses of total and weakly-extractable contaminants, and porewater contaminants will aid interpretation of bioavailability and toxicity test data. For sediments that undergo major manipulation (e.g. sieving) or are stored for long periods of time before testing (e.g. longer than 4 weeks), reanalysis is desirable for those parameters likely to be affected by these manipulations (e.g. pH, AVS, pore waters, volatile organics).

3.4.1 Sieving

Sieving of sediments causes major changes to sample integrity and possible losses of different sediment components (e.g. volatilisation of organics). Valid reasons for sieving sediments may include:

- (i) Sediments contain large amounts coarse material (debris, rock, shells, wood >2 mm in diameter) that will interfere in analyses;
- (ii) Information is required on the distribution of contaminants in different sediment size fractions; or
- (iii) It is necessary to remove indigenous organisms from the sediments prior to performing toxicity tests.

For toxicity tests, it is preferable that none of the tested sediments be sieved. However, if test procedures require sieved sediment, then all of the tested sediments, including control and reference sediments, should be sieved. In some cases, indigenous organisms may be handpicked from the sediments. Indigenous organisms may confound results of toxicity tests by being similar to test organisms or by preying on the test organisms. To remove indigenous organisms, the most appropriate procedure is press sieving, whereby the sediments are pressed through a chemically-inert sieve, using either a gloved hand or chemically-inert spatula. Generally, 1 mm sieves should be sufficient for removal of most problematic macrofauna. As an alternative to

sieving, organisms may be handpicked (using forceps) from sediments following spreading out of the sediment in a shallow tray. A record should be made of what is retained on the sieve (e.g. organisms, shells, gravel, and other debris). Water should not be used to wash sediment through sieves when sediments are to be used for toxicity testing because this will remove contaminants and alter bioavailability. Samples that are to be used for both chemical analysis and toxicity tests should be sieved together, homogenised, and then split for their respective analyses. Sieving (or handpicking) may need to be carried out in an oxygen-free atmosphere to minimise oxidation of sediment components.

Wet sieving of sediments is recommended when information is required on contaminant partitioning between different sediment size fractions. Samples should be thoroughly homogenised before wet sieving is undertaken. Deionised water should be used to wash the sediment through a chemically inert sieve material with the aid of a chemically inert spatula. Sieves and spatulas should be high quality stainless steel when organics are the main contaminants of interest, or non-adsorbing plastics (e.g. nylon, polyethylene, polypropylene, Teflon) when metals are to be analysed. Generally the silt fraction of the sediments (approximately $63\ \mu\text{m}$) is considered to be the most important with regard to contaminant partitioning, especially for metals. Some redistribution of contaminants to the finer sediment fraction may be expected due to solubilisation of larger particles. If there is a concern about losses and redistributions of contaminants during sieving, the recommendation is to undertake only total contaminant analyses, with wet sieving used to determine the grain size distribution only on a separate sub-sample.

3.4.2 Collection of pore water from sediment

Sediment pore water is defined as the water occupying the spaces between sediment particles. Typically pore water will occupy 30-80% of the volume of sediment, the volume being greater for fine-grained (silty) sediments than for sandy sediments. Water currents

driven by surface water movements (e.g. currents, tides, wind) or groundwater upwelling will influence porewater composition and stability. In most depositional sediments, pore waters will be relatively static and it is expected that thermodynamic equilibrium will exist between contaminant concentrations in the pore water and in surrounding sediments. The concentrations of contaminants in the pore waters of surface sediments (0-1 mm) will control the flux of contaminants to the overlying waters or into the burrows of organisms. Sediment characteristics (e.g. pH, organic carbon, sulfides, mineralogy, particle size) will greatly affect the partitioning of contaminants between the sediments and pore waters (Di Toro et al., 1991; Chapman et al., 1998). Porewater contaminant concentrations are frequently higher than overlying water concentrations and are easily dispersed and diluted within the system.

Because many benthic organisms are in direct contact with sediment pore waters, this component of sediments is considered to be a major exposure pathway for benthic organisms. The accurate measurement of contaminant concentrations in sediment pore waters is therefore useful for assessing the bioavailability of contaminants. Pore waters are often isolated from the sediment matrix for toxicity testing with organisms that are sensitive to dissolved contaminants. The information obtained from porewater toxicity tests is useful for contaminated-site assessment programs as it provides additional information to that obtained from whole-sediment and elutriate toxicity tests (Carr and Nipper, 2003). Many of the most well developed procedures for toxicity identification evaluation (TIE) of sediment contaminants involve the manipulation of sediment porewater chemistry following isolation from whole sediments (Ho et al., 2002; NFESC, 2003).

Porewater sampling, chemical analysis and toxicity testing are usually only undertaken for sediments for which total contaminant concentrations are above guideline screening values (ANZECC/ARMCANZ, 2000a). Generally, sediments with coarse particle size (sand/

gravel) that have little binding capacity for sediment contaminants, or compacted clays that have little pore water with which organisms can interact, will not require evaluation. Detailed guidance and recommendations on porewater toxicity testing including porewater extraction methods and applications are available in a recent publication from a Pellston workshop (Carr and Nipper, 2003).

A large variety of methods have been used for the isolation of pore waters from sediments (Carr and Nipper, 2003; Chapman et al., 2002b). It is important to recognise that all methods have been shown to alter porewater chemistry and affect metal contaminant bioavailability and toxicity (e.g. Bufflap and Allen, 1995; Sarda and Burton, 1995; Chapman et al., 2002b, Simpson and Batley, 2003). Because pore waters will generally contain very low dissolved oxygen concentrations, and often have high concentrations of easily oxidisable species (e.g. Fe(II)), maintaining these properties following isolation from sediment is practically impossible (Simpson and Batley, 2003). Several good reviews are available that discuss porewater sampling, precautions and artifacts (Carr and Nipper, 2003; Chapman et al., 2002b).

The extraction of pore waters by centrifugation or squeezing (*ex situ* extractions) will generally be the most useful for obtaining pore waters for chemical analyses or toxicity testing. Centrifugation is the preferred laboratory method as it is a relatively simple procedure that allows rapid collection of large volumes. If information is required on the vertical distributions of porewater contaminants in sediments, then porewater peepers will generally be the most appropriate technique (Bufflap and Allen, 1995; Carignan et al., 1985; Teasdale et al., 1995). Because *in situ* techniques using peepers or suction techniques generally produce insufficient volumes of pore water for toxicity testing purposes, they are generally of limited use for assessing sediment quality. Extraction of pore waters should be completed as soon as possible after sample collection.

When pore waters are to be used for toxicity tests, filtration should generally be avoided as studies have shown that filtered samples generally have lower toxicity than unfiltered samples (Carr and Nipper, 2003). This may be expected due to filtration procedures generally removing a larger proportion of fine or colloidal solids than is achieved by centrifugation or squeezing techniques. For accurately characterising sediment toxicity, colloidal material and fine particles present in the pore water may be of importance.

Because most sediments are anoxic at depths greater than 2-3 mm, porewater extractions from sediments should be conducted in an inert atmosphere or with minimal atmospheric contact. Significant chemical changes can occur even when pore waters are stored for periods as short as 24 h (e.g. Hulbert and Brindel, 1975; Sarda and Burton, 1995; Carr and Nipper, 2003; Simpson and Batley, 2003). Air exposure will result in the rapid oxidative precipitation of dissolved iron(II) as iron hydroxide and slower oxidation of dissolved manganese(II) and sulfide. Following isolation of sediment pore waters from sediments, the pore waters should be stored so that oxidative changes, adsorption to containers or volatilisation are minimised (Carignan, 1984). Containers should be filled, with no headspace, to minimise changes in dissolved oxygen and contaminant bioavailability. Porewater samples for chemical analyses should be preserved immediately, if appropriate (e.g. acidification for metal analyses, frozen or preserved for pesticides, phenols analyses), or cooled to 4°C as soon as possible. Porewater samples to be used for toxicity tests should be cooled to 4°C immediately after isolation and used in tests as soon as possible. Storage containers should be appropriate with regard to adsorption or leaching of chemicals.

3.4.3 Preparation of sediment elutriates

Sediment elutriates are commonly used for assessing the effects of dredging operations on

water quality (Environment Australia, 2002; USEPA/USACE, 1998). Elutriate manipulations are also applicable to any situation where the resuspension of sediment-bound toxicants is of concern, such as bioturbation and storms, that might disturb sediments and affect water quality. Elutriate procedures should suit the intended study, but the general method for elutriate preparation involves combining of water and sediment in a ratio of 4 parts water to 1 part sediment (by volume) and end-over-end shaking the mixture for 1 h (USEPA/USACE, 1998). After the 1-h mixing period, the mixture is allowed to settle for 1 h. The supernatant is then siphoned off and centrifuged to remove particulates prior to chemical analysis. When elutriate waters are to be used for toxicity tests, water filtration should generally be avoided as studies have shown that filtered samples generally have lower toxicity than unfiltered samples (Carr and Nipper, 2003). Recentrifuging elutriates may be a better alternative than filtration. If filtration is necessary, filters should be pre-treated (cleaned, soaked) and the first 10 mL of elutriate to pass through the filter discarded (Environment Canada, 1994). The dissolved or colloidal contaminant retained (adsorbed) by the filter may require analysis. Elutriates should be analysed or used in biological tests as soon as possible after preparation. If the elutriate requires storage, this period should be no longer than 24 h and storage should be at 4°C with minimum headspace in the storage container (Geffard et al., 2004).

3.4.4 Spiking of sediments

The spiking of sediments with particular chemicals is undertaken (i) to check recoveries of analytes (QA/QC), (ii) to understand the partitioning (between sediments and waters) of chemicals in different sediment matrices, (iii) to understand the transformation rates (degradation, volatilisation) of chemicals in different sediment matrices, and (iv) to quantify the effects of known concentrations of chemicals in toxicity tests.

Because sediment spiking will involve major manipulation of sediment properties, a high level of importance should be given to documenting procedures and carefully

measuring and reporting sediment parameters (e.g. moisture content, pH, redox potential, TOC, AVS, iron, porewater constituents: ammonia, sulfide, iron, metals) so that losses/recoveries of added chemicals can be assessed and the bioavailability of the added chemical (or other chemical present) be accurately determined. Failure to report these parameters will make it difficult to interpret results and assess contaminant exposure pathways and organism sensitivities (Simpson et al., 2004). Control sediment should undergo the same treatment as spiked sediments. Full descriptions of spiking procedures should be reported.

The choice of spiking techniques should be made to suit the particular project, as well as both the properties of the added chemical and the type of sediment being spiked. Sediment properties have a major influence on the ability to sequester contaminants (Stemmer et al., 1990a,b; Besser et al., 2003). Debris and indigenous organisms should be removed from sediments before spiking. Wet spiking techniques are recommended over dry spiking, as this will facilitate sediment-water interactions. For large batches of spiked sediments, rolling spiked sediments in containers (perhaps in combination with hand mixing) generally achieves better mixing than hand mixing.

Slurry spiking is the preferred technique for spiking sediment (Landrum et al., 1992; Northcott and Jones, 2000; Carr and Nipper, 2003; Simpson et al., 2004). Where possible, spike-solutions should be deoxygenated before adding to the wet sediments. Dissolved oxygen has been shown to facilitate oxidation of porewater constituents, particularly iron(II) and cause the sediment pH to decrease (Simpson et al., 2004). Adjustments of sediment pH may be necessary if the pH of the sediments drops significantly during spiking and equilibration (Simpson et al., 2004). Containers should not be overfilled (<70%) and the fluidity of the spiked sediment-water mixture should be sufficient to facilitate mixing. This will depend on the sediment properties (especially particle size), but generally, a 4:1 water to sediment ratio will be sufficient for rapid mixing. Prolonged mixing

should be avoided as this may not significantly increase sediment homogeneity but will cause greater changes to the sediment properties (e.g. oxidation of sediment components). Mixing of sediment-water slurries by rolling for an hour, twice daily, for a week, with storage of sediments closed to the atmosphere between mixing periods, should be sufficient for obtaining heterogeneity. During mixing, filling the headspace of the container with an inert gas (e.g. nitrogen, argon) is useful to prevent air mixing with the sediments.

As a general guide, a one-month equilibration period after spiking of sediments is required before use, but measurements of sediment parameters indicative of contaminant equilibration (e.g. porewater and weakly-extractable contaminant concentrations) will indicate whether the equilibration period can be shortened or requires lengthening to achieve the desired properties. The temperature used during equilibration of the spiked sediments should be selected to facilitate equilibration of the sediments. Spiked-metals have been shown to equilibrate with sediment much faster at room temperature than at 4°C. The microbiological properties of sediments will also be affected by the equilibration temperature (Verrhiest et al., 2002; Simpson et al., 2004). Following the mixing or equilibration period, it will generally be necessary to remove the excess water and adjust the sediment to the desired moisture content. This can be easily achieved by centrifuging the sediment, decanting the supernatant water, and adding clean water (e.g. seawater, river water) to obtain the desired water content per gram of dry sediment. The residual contaminant concentration in the supernatant should be measured to calculate partition coefficients.

The adequacy of sample homogenisation (uniformly distributed chemical) and equilibration time (affects chemical speciation and partitioning between sediments and pore waters) should be checked and documented. Equilibration times of at least one month are generally recommended, but this will depend on the concentration and properties of the spiked chemical and the properties of the sediments (Carr and Nipper, 2003; Simpson et al., 2004).

Metal-spiked sediments

The following key recommendations are given for the preparation of metal-spiked sediments for toxicity testing:

- (i) Air penetration into sediments should be minimised by using deoxygenated waters for preparing metal-spike solutions and an inert gas (e.g. nitrogen) to occupy the bottle headspace during mixing. This will minimise oxidation reactions that cause the pH to decrease.
- (ii) When spiking metals into sediments, the decrease in porewater pH caused by hydrolysis reactions may require neutralising. Buffer solutions are not suitable for increasing the pH of sediments that are naturally well buffered, and a strong base, e.g. NaOH, will generally be required.
- (iii) Neutralisation of pH changes should be made at least 2 h after metal additions and sediment mixing to allow natural metal precipitation, adsorption, and ion-displacement reactions to occur before NaOH additions are used to neutralise displaced protons. This will lower the formation of metal-hydroxide colloids or precipitates that may be slow to equilibrate with other sediment phases (e.g. sulfide).
- (iv) Metal additions will cause the displacement of iron(II) into the pore waters, which will subsequently oxidise and hydrolyse resulting in decreases in pH and increases in redox potential:

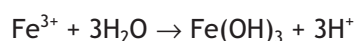
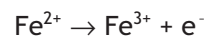

High iron(II) concentrations (>100 mg/L) in the pore waters may affect the bioavailability of other porewater metals. Increasing the pH to greater than pH 7.5 and then mixing will result in the rapid precipitation of most porewater iron.

- (v) Equilibration rates of porewater metals vary considerably and are dependent on sediment and metal properties. Recommended equilibration times for

oxic/sub-oxic sediments similar to those of this study are: 25-45 d for Cd, 10-15 d for Cu, 30-70 d for Ni, and 20-40 d for Zn. Porewater metals will equilibrate faster in sediments with high concentrations of metal-binding sites (e.g. iron, organic matter and sulfide) and large surface areas (fine, silty sediments) than in sandy sediments with low binding capacities. Equilibration rates will be slower in oxic/sub-oxic sediments than in sulfidic sediments.

- (vi) Following metal additions, equilibration times greater than 70 d may be required to reduce the bioavailability of particulate metals (e.g. acid-soluble metals) due to the slow re-equilibration rates for adsorbed metals or metal precipitates.
- (vii) AVS is a strong metal-binding phase in sediments and the AVS concentration may be used to estimate when porewater concentrations should be negligible and help predict the order in which different metals will be observed in the pore waters (Berry et al., 1996). The formation of AVS occurs slowly during the equilibration of sediments, and the addition of sulfide may be useful if metal sulfide formation is desired.
- (viii) Sediments equilibrate more slowly when incubated at 4°C than at room temperature (18-25°C) resulting in high porewater metal concentrations of all metals. Disturbances to sediments during sample manipulation will cause iron(II) oxidation and losses of metals from pore waters through adsorption of fresh iron hydroxide precipitates. This may be used to advantage to keep metal concentrations low in pore waters. Metal-spiked sediments should be equilibrated at room temperature.
- (ix) Additions of metals to sediments and incubation (conditioning) of sediments may change bacterial and algal populations and poison food sources. Consideration should be given to how these changes will affect contaminant bioavailability and food sources of the test species. The addition of clean food

sources may be required following the equilibration of spiked sediments.

- (x) It is recommended that porewater metal concentrations, pH and redox potential be measured at regular periods during sediment equilibration and at the beginning and end of tests, and reported when publishing toxicity test results.
- (xi) The homogeneity of the spiked compound should be determined and reported.
- (xii) Measurements of metals in overlying waters should be made following transfer of sediments to test containers and during organism exposure experiments. Fluxes of metals from the sediments to the overlying waters will provide valuable information on the disturbances test organisms cause to the equilibrated metal-spiked sediments. Changes to overlying water concentrations will affect the response and exposure pathways of test organisms.

Organic compound-spiked sediments

For the preparation of sediments spiked with organic compounds, the following key recommendations are given:

- (i) Most of the factors that are important for metal-spiked sediments (listed above) are also important for organic-spiked sediments
- (ii) Samples should be maintained under field moisture conditions and not dried and rewetted during spiking procedures.
- (iii) Careful consideration should be given to the choice of organic carrier solvent for spiking (solvent persistence, volatility, toxicity)
- (iv) The amount of carrier solvent used should be kept to a minimum and be the same for controls and all spike concentrations. Spiking methods that involve coating the spiking container with the organic compound followed by volatilisation of excess solvent are useful for minimising effects of carrier solvents (Driscoll and Landrum, 1997; Cole et al.,

2000; Burgess et al., 2000; Northcott and Jones, 2000; Carr and Nipper, 2003).

- (v) Mixing should begin immediately after spiking and be sufficient to achieve homogeneity but minimised to prevent unnecessary disturbances to sediment properties. The homogeneity of the spiked compound should but be determined.
- (vi) If possible, the persistence of the carrier solvent in the sediment should be determined and effects on biota evaluated.
- (vii) As many PAHs degrade under ultraviolet light and the degradation products may exhibit greater toxicity than the original compounds (Ankley et al., 1994), spiking and equilibration of PAH-spiked sediments should occur in the dark, or at least under low light.
- (viii) Short equilibration times (e.g. 24-72 h) may be suitable for organic compounds with low octanol-water partition coefficients (K_{ow}), while organic compounds with a high partition coefficient might require months to establish equilibrium (Landrum et al., 1992). Because organic contaminants may undergo microbiological degradation, this may be another important factor in the choice of an appropriate equilibration period.
- (ix) Measurements should be made of the amount and type of organic carbon in the sediments as this will greatly affect the rates of equilibration and partitioning of organic spikes (Gustafsson et al., 1997, 2001).

It is important to realise that any manipulation of sediment properties will affect contaminant bioavailability and detailed analyses of sediment properties (e.g. pH, redox potential, total organic carbon, AVS, iron, particle size analysis, and analyses of contaminants total, weakly-extractable, porewater sediment fraction) are necessary to interpret the effects on the outcome of the toxicity test results.

Dilution of spiked or field-contaminated sediments with clean sediment may be a useful way of obtaining information on threshold

concentrations for sediments contaminants. The diluent sediment should, ideally, have physicochemical characteristics (e.g. particle size, total organic carbon, iron, AVS) identical to the test sediment. As this will not generally be possible, consideration of how changes in the sediment properties will affect contaminant bioavailability (other than through dilution) will be necessary. If sediment dilution techniques are used, care should be taken to thoroughly mix the sediments and the homogeneity of the final sediment preparation should be carefully checked before use in tests.

Modification of sediment organic carbon content will affect the partitioning (and bioavailability) of both non-ionic organic chemicals (Di Toro et al., 1991; DeWitt et al., 1992; Kosian et al., 1999) and metals (Besser et al., 2003; Simpson et al., 2004). Modification of sediment sulfide concentrations (e.g. AVS) will affect the partitioning of metals (Gonzalez, 1996; Leonard et al., 1999).

3.5 QA/QC Procedures for Sediment Collection and Manipulation

Field replicates and field blanks are important components of all sediment assessment programs. These samples should be collected and handled exactly the same as the sediment samples and should be treated as blind samples so as to minimise bias in the analysis. Replicate samples may reflect the variability in sediment composition more than the collection technique used. Clean sand may be used for field blanks for sediment samples and should be placed in contact with the sampling equipment before transfer to the storage container. For very volatile chemicals, spiking in the field may be a useful way of estimating losses occurring during transport and prior to testing. Chain-of-custody forms should accompany all samples from the time of collection through to reporting of analysis results.

4 CHEMICAL AND PHYSICAL CHARACTERISATION OF SEDIMENTS

4.1 Sediment Heterogeneity

As discussed earlier, sediments, unlike water, can be remarkably heterogeneous. Spatial heterogeneity both in grain size and in contaminant distribution has been shown to involve microniches with high concentrations of contaminants (Shuttleworth et al., 1999) and high bacterial activity. The influence of the bioturbation (organism burrowing) and bioirrigation (the introduction by organisms of overlying water into burrows) behaviour of organisms on the migration of sediment contaminants is well documented (Forster, 1996; Petersen et al., 1998; Ciarelli et al., 1999; Rasmussen et al., 2000; Ciutat and Boudou, 2003; Simpson and Batley, 2003). The different feeding and burrowing behaviours of organisms affects how they sort particles, enrich or deplete organic matter, inject oxygen into localised sediments and alter contaminant fluxes from sediments. Some of these complex issues may challenge our more simplistic view of sediment chemistry that underpins SQGs and their application, where sediments are considered as homogeneous and in some instances are homogenised prior to investigation.

The effects of localised heterogeneity with respect to organic contaminants was illustrated by Guerrero et al. (2003) in a study of pyrene bioaccumulation by clams with various types of artificial sediments and a natural one. Variations in the sediment water partition coefficient (K_d) of the particles defined the window of bioavailability for pyrene when it was adsorbed on the surface of ingested sediments. However, the natural sediment tested did not fit easily into the partitioning interpretation. The main reason for that could be that K_d is really only meaningful for a single defined surface. In natural sediments, there is a large range of components each with a different partition coefficient, so that the averaged value that is

measured experimentally is relatively meaningless. This could be particularly true if the test organism is a selective feeder that may ingest components of the sediment with quite specific K_d values that differ considerably from those of the 'bulk' phase.

The microbial degradation of labile organic matter in bulk sediments determines the redox potential (Eh) and the pH observed at various depths in bulk sediment, and is responsible for a variety of secondary reactions involving trace metals (e.g. desorption, release to pore water, fixation as sulfides). These redox reactions lead to vertical zonation of pH, Eh and various chemical species in sediments. Since the flux of labile organic matter to the sediments is usually much faster than the diffusive flux of oxygen across the sediment-water interface, it is commonly observed that oxygen drops to zero within a few mm below the sediment-water interface. Sediments are, thus, anoxic well above the depth to which most benthic animals burrow.

In addition, during the microbial degradation of organic matter in the sediments, reduced forms of the electron acceptors are produced and released to the pore waters. Some of these solutes, such as sulfide, are toxic to most benthic animals. The natural concentrations of sulfide found in pore water are not toxic to most invertebrates (Wang and Chapman, 1999). It is important that such dynamics are understood and the chemical changes that occur when such sediments are disrupted are appreciated when designing and conducting laboratory toxicity tests from field-collected sediments, and from artificially-prepared test sediments. Lee et al. (2000a), for example, documented how disruption of anaerobic sediment spiked with four metals shifted the exposure from ingestion of particulates (the primary route *in situ*) to porewater exposure.

4.2 General Sediment Quality Parameters

There are a number of indirect stressors that modify sediment chemistry thereby affecting contaminant bioavailability. Measurements should be made of pH, redox potential, moisture content, particle size analysis, total organic carbon, AVS, particulate iron and manganese, porewater constituents (iron, manganese, ammonia, sulfide) and contaminants of concern in the different sediment fractions (total, weakly-extractable, pore water). The pH and redox potential measurements should be made in the field on surface and depth sediments (the latter only if sectioned in field). It may be useful to repeat some measurements (e.g. pH, redox potential, porewater iron, AVS) before and after sample manipulation. In estuaries, porewater salinity should be measured as it is frequently significantly different to that of the overlying water salinity (Chapman and Wang, 2001).

Important measurements of overlying water quality include pH, redox potential, dissolved oxygen, temperature, conductivity/salinity, turbidity in the water column, 5-20 cm above the sampling site. Total water depths, the amplitude of tides and light penetration near the sediment-water interface will also aid data interpretation.

4.2.1 Sediment pH and redox potential

Sediment porewater pH is the master variable controlling the speciation and bioavailability of metals. The water quality guideline values for ammonia, cyanide, and sulfide (all of which ionise as a function of pH) are pH dependent (ANZECC/ARMCANZ, 2000a). The redox potential (E_h) of the sediment is an important factor controlling the partitioning of metals in sediments, particularly iron and manganese oxidation states and metal-sulfide chemistry of Ag, Cd, Cu, Fe, Hg, Ni, Pb and Zn. The oxic zone is frequently of the order of a few mm of surficial sediment, underlain by a sub-oxic and then anoxic area. The presence of acid-volatile sulfides (FeS, MnS) is a buffer against metal release to pore waters because of their ability to exchange with soluble metals, and this will impact directly on bioavailability if this is the

preferred uptake route. E_h values < -150 mV are indicative of sulfide-reducing conditions, while E_h values of -50 to 100 mV indicate iron(III)-reducing conditions. However, sulfide and iron reduction zones may overlap and boundaries are difficult to define and are dependent on pH (Stumm and Sulzberger, 1992). The pH- and redox-dependent equilibrium between iron(II) in pore waters and the formation of iron(III) hydroxide phases is very important in controlling concentrations of porewater metal contaminants (Vink, 2002; Simpson and Batley, 2003). Both pH and redox potential measurements provide useful process-related information on the nature of the sediments under investigation.

The measurement of sediment pH and redox potential are really measurements of the pore water rather than the sediment. Electrodes are available for both, but the act of insertion into the sediment may disturb the redox and pH profiles, so it is important to allow time for the equilibrium to re-establish before taking a measurement. The use of 'spear tip' pH (combination) electrodes that allow greater penetration into the sediments is the preferred approach for sediment pH measurements. Potentiometric measurements of redox potential should be made using a millivolt reader and graphite or platinum electrodes with combination silver-silver-chloride or calomel reference electrodes (ASTM, 1998; APHA, 1998). The millivolt reading should be reported versus the normal hydrogen electrode (NHE) as E_h , and can be calculated from the measurement as follows:

$$E_h = E_{\text{obs}} + E_{\text{ref}}$$

where E_h = measured redox potential (mV) reported versus NHE, E_{obs} = observed redox potential for electrode pair used, and E_{ref} = redox potential of the reference electrode versus NHE.

The NHE is fragile and impractical to use directly. A number of redox standard solutions can be used to determine E_{ref} , e.g. Light's solution (E vs NHE = 675 mV, at 25°C), Zobell's solution (428 mV), and quinhydrone solutions (285 mV at pH 7, 462 mV at pH 4). As the redox potential will depend on the type of

reference electrode used, the offset introduced must be compensated for. If, for example, a potential of 86 mV was obtained for the quinhydrone pH 7 redox buffer (at 25°C) (typical of E vs Ag/AgCl), then use $(285 \text{ mV} - 86 \text{ mV}) = 199 \text{ mV}$ as the offset. Each of these redox buffer solutions has a different storage life, ranging from hours to months. The use of Zobell's solution is recommended, but it is toxic and subject to oxidation (store in dark). Other commercially available redox standards are available (e.g. triiodide/iodide by Orion Research, Inc.). Redox potential measurement inaccuracy due to disturbance of the sediment sample during insertion of the electrode, instability and poor reproducibility of the measurements are common. Acceptable error ranges for pH and redox potential measurements for sediments will be of the order ± 0.1 pH units and 20-40 mV respectively.

4.2.2 Water content

It is usual to refer measurements on sediments to the dry weight content, but it is frequently preferable to undertake contaminant analyses on a wet sediment, because drying can alter the chemistry and in some instances result in losses. Water content is therefore required to convert these data to the preferred dry weight units.

Water content (often called moisture content) of wet sediment is determined gravimetrically by measuring the mass of water lost following drying at 110°C (Mudroch et al., 1997). Before taking a sub-sample for moisture analysis, the sediment should be well mixed so that the water is evenly distributed throughout. The combined determination of sediment water content, density and porosity can be made according to the methods described in Mudroch et al. (1997). Measurements of sediment density and porosity are often useful parameters for describing sediment characteristics.

4.2.3 Particle size

Sediment particle (grain) sizes generally range from sand, through silty sand, sandy-silt, to clays, although shells and other detritus may also be a significant proportion of many

sediments. The surface areas of these materials vary over orders of magnitude, so too do they differ in the number of binding sites for metal and organic contaminants. Particle size often defines whether a sediment is a good habitat for biota (suitability for easy burrowing, burrows not collapsing, etc.). Some species show preferences for particular particle-sized sediments while others can happily survive independent of particle sizes. Particle size will also influence benthic community structure. Fine sediments are typically those that are most heavily contaminated (greater surface area and more binding sites). A contaminant at a given bulk concentration in a sandy sediment will generally be more toxic than the same concentration in a silty sediment, because the partitioning to pore water will be greater. Because particle size influences both chemical and biological characteristics, it can be used to normalise chemical concentrations and account for some of the variability found in toxicity testing results and ecological datasets (e.g. biological assemblages).

Sediment particle size analysis can be made by wet sieving, hydrometer or pipette methods or by laser particle size analysis (Mudroch et al., 1997). Wet sieving is the recommended method and should be undertaken on the wet sediment, using standard nylon or stainless steel sieves. This may be achieved by using deionised water to wash the wet sediment through (for example) 1 mm, 180 μm and 63 μm sieves. The sediment passing through the finest sieve and the sediment retained on each sieve is quantitatively collected and the relative amounts determined gravimetrically (by weighing) following drying of the respective sediment size fractions.

4.2.4 Total organic carbon

The total organic carbon (TOC) content of sediment is the sum of particulate organic carbon (POC) and dissolved organic carbon (DOC). Decaying detrital particulate organic matter is distributed amongst mineral and amorphous particles in sediments and is a site for bacterial activity. These and organic coatings on inorganic particles provide binding sites for both metal and organic contaminants.

Other organic carbon-containing substances in sediments may include wood debris, ash, soots, oil and tar. The binding of hydrophobic organic contaminants to these phases will have quite different partition coefficients. In the ANZECC/ARMCANZ (2000a) guidelines, all organic contaminants are normalised to the total organic carbon (TOC) concentration of the sediment (i.e. normalised to 1% TOC).

TOC is a measure of the total amount of oxidisable organic material. The analysis of TOC will generally be made using high temperature dry combustion techniques (e.g. CHN or TOC analysers) (Mudroch et al., 1997). Chemical oxidation techniques are not recommended because some organic compounds may not be analysed by these techniques. Inorganic carbon (e.g. carbonates and bicarbonates) can be a significant proportion of the total carbon in some sediments. TOC analyses are undertaken on dried (75-110°C) samples following the removal of inorganic carbon (by heating the sample with dilute acid, until effervescence due to carbonates ceases). The methods generally have a limit of determination of 100 mg/kg. Estimation of the sediment organic carbon content may also be achieved by 'loss-on-ignition' (LOI) by heating a known mass of dried sediment at ~400°C for 24 h followed by gravimetric analysis. However, these gravimetric analysis techniques are less accurate due to possible losses of other volatiles and are often subject to the choice of LOI temperature (variations from 350 to 500°C have been used).

Black carbon (pyrogenic carbon or soot) has been shown to be an important phase for binding hydrophobic organic contaminants (e.g. PAHs) in sediments (Gustafsson et al., 1997). Black carbon is produced from the incomplete combustion of fossil fuels and vegetation. Hydrophobic organic contaminants are generally much more strongly associated with (partitioned to) black carbon than other forms of natural organic matter. The differentiation of black carbon from other forms of carbon is usually made on the basis of the temperature of combustion. An oxidation temperature of 375°C has generally been found to provide a reasonable distinction between

black carbon and non-black carbon (Gustafsson et al., 2001). Black carbon measurements are recommended for assessments of sediments containing high concentrations of hydrophobic contaminants. This information will be useful in understanding the forms of carbon that may be involved in partitioning reactions and will assist in estimating partitioning coefficients used for predicting of PAH bioaccumulation.

It is recommended that high temperature dry combustion techniques (e.g. CHN or TOC analysers) be used for analyses of particulate organic carbon where measurements are to be used to 'normalise' organic contaminant concentrations to sediment TOC (as recommended in the ANZECC/ARMCANZ (2000a) guidelines). LOI measurements are useful when additional information is sought on relative differences in sediment organic carbon concentrations (e.g. considerations for metal partitioning).

4.2.5 Acid-volatile sulfides

As discussed earlier, the sulfide content of a sediment is a key modifier of the bioavailability of several metals (Di Toro et al., 1990; Ankley et al., 1996; Berry et al., 1996; Simpson et al., 1998). Trace metals in sediments are generally believed to react with FeS (the major component of AVS) to form metal sulfides according to:

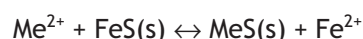

In general, appreciable concentrations of Cd, Cu, Ni, Pb and Zn will not be observed in pore waters until the reservoir of FeS is exhausted. Measurement of AVS concentrations (mmol/kg) and comparison against the molar sum of acid-soluble metals (often termed simultaneously extracted metals or SEM, mmol/kg) is a useful indicator of the bioavailability of metals in sediments. If AVS is greater than SEM, the metals are likely to be bound in sulfide complexes with greatly limited bioavailability. However, if AVS < SEM, metals may or may not be toxic due to other controlling factors (e.g. TOC, iron hydroxides).

AVS is operationally defined as the fraction of sulfides extracted from sediments by cold

dilute HCl (usually 1 h in 0.5 M HCl or 30 min in 1 M HCl) (see Appendices 2 and 3). Iron and manganese monosulfides constitute the majority of the sulfide extracted by AVS methods. SEM is calculated as $\Sigma(\text{Cd,Cu,Ni,Pb,Zn})$ in mmol/kg. The differential approach (SEM-AVS) is the preferred representation of results, rather than the more traditional ratio approach (SEM/AVS), which tends to misrepresent available concentrations of SEM at low AVS concentrations. Using the differential approach, an SEM-AVS value of 5 mmol/kg dry weight is recommended as a screening value for identification of sediments of concern with regard to potential effects from metals.

A range of methods has been used for determining the AVS content of sediments. The most common technique is a 'purge-and-trap' method employing 0.5-1 M HCl to volatilise the AVS, with the trapping of the liberated hydrogen sulfide in 0.5 M NaOH (Di Toro et al., 1990; Allen et al., 1993; Simpson et al., 1998), as detailed in Appendix 2. The trapped sulfide is generally analysed using colorimetric or specific-ion electrode analysis. A simple 'diffusion' system employing relatively inexpensive glassware has been shown to produce comparable results to the purge-and-trap method (Brouwer and Murphy, 1994; Leonard et al., 1996). The detection limit of each of these methods is generally 0.05 mmol/kg sediment (dry weight). More recently, a 'rapid' method of measuring AVS in sediments was developed that utilises the direct reaction of a small amount of sediment with a reagent followed by colorimetric determination of AVS without the need for specialised glassware or equipment (Simpson, 2001) (Appendix 3). A comparison between the rapid and purge-and-trap AVS methods indicated a linear relationship, although the method underestimates the AVS concentration measured by the purge-and-trap method by up to 20%. The detection limit of the rapid AVS method is generally 0.5 mmol/kg sediment (dry weight). AVS concentrations can range between <0.05 and >200 mmol/kg of sediment.

Artifacts of the AVS methods include the partial to full insolubility of CuS and NiS phases

in 1 M HCl (Simpson et al., 1998; Cooper and Morse, 1998). Iron(III) minerals (e.g. FeOOH, Fe(OH)₃) that are found in most depositional sediments may cause an underestimation of AVS concentrations (Simpson et al., 1998; Hsieh et al., 2002). To minimise the oxidation of AVS by Fe(III), addition of ascorbic acid is recommended (Hsieh et al., 2002). Recent studies have shown that although sediments have an excess of AVS over SEM, metals may be bioavailable through sediment ingestion (Lee et al., 2000a,b, 2001). The presence of metal contaminants as both sulfide and oxide phases in reduced, anoxic sediments may make it difficult to predict or interpret causal effects using AVS (Simpson et al., 2000; O'Day et al., 2000).

It is recommended that the 'purge-and-trap' or 'diffusion' methods for AVS analysis be used, but the rapid AVS method will be useful for screening of AVS concentrations in sediments at substantially reduced costs (see Appendices 2 and 3 for more details). Data analysis should carefully consider the solubility of the different sulfide phases (during extraction) and possible interferences from iron(III).

4.3 Sediment Contaminants

4.3.1 Particulate metals and organometallics

Total particulate metals analyses are best undertaken on an aliquot of moist, homogenised sediment, with a separate sample being taken for moisture analysis. It is normally necessary to solubilise the metals by digestion in an acidic medium. Digestion of the sample can be undertaken using microwave-assisted digestion using a mixture of nitric, hydrofluoric and hydrochloric acids (or combinations). Analyses of the diluted digests can be undertaken most conveniently using inductively coupled plasma atomic emission spectrometry (ICPAES) (or inductively coupled plasma mass spectrometry (ICPMS)). Hydride generation furnace atomic absorption (HGFAAS) or atomic fluorescence spectrometry (AFS) is usually required for arsenic and selenium, and cold-vapour atomic absorption spectrometry (AAS) or AFS for mercury. Easily

Table 3. Summary of limits of determination (LOD) for analyses for common contaminants in sediments

Sediment Chemicals	LOD	Units
Ag, As, Cd, Co, Cr, Cu, Ni, Pb, Sb, Se V, Zn	0.2-1	mg/kg
Mercury	0.001	mg/kg
Methylmercury	0.01	mg/kg
Tributyltin (TBT)	0.5	µg/kg
Polycyclic aromatic hydrocarbons (PAHs)	0.01-0.2	mg/kg
Total petroleum hydrocarbons (TPHs)	25-100	mg/kg
Benzene, toluene, ethylbenzene, xylene (BTEX)	0.5-1	mg/kg
Total polychlorinated biphenyls (PCBs)	0.01-0.1	mg/kg
Phenols	0.1-2	mg/kg
Organochlorine pesticides	0.01-0.001	mg/kg
Organophosphate pesticides	0.1	mg/kg
Synthetic pyrethroids	0.05	mg/kg
Carbamates	0.05	mg/kg
Phenoxy-acid herbicides	0.1	mg/kg
Phthalates	1-2	mg/kg
Carbamates	0.05	mg/kg
Bromoxynil, propyzamide, glyphosate	0.1	mg/kg
Dioxin TEQ	0.1-1	µg/kg

achievable detection limits are shown in Table 3. Concentrations of Fe and Mn should also be reported if the results are to be related to metal partitioning in sediments. It is recommended that certified reference materials (CRMs) be analysed as a check of analysis accuracy (quality control).

For most metals, the most reactive and bioavailable fraction (i.e. the metal fraction of interest in sediment quality assessments) are those that can be easily extracted with cold dilute acid. Stronger digestion procedures, e.g. using microwave methods with aqua regia or hydrofluoric acid, are not considered necessary for most sediment quality assessments. The former is recommended in the ANZECC/ ARMCANZ (2000a) interim SQGs. Acid-soluble metals are best determined by reacting the sediment with cold 0.5-1.0 M hydrochloric acid in a sediment:acid ratio of 1:50 for 1 h. This extraction is analogous to the extraction of metals used in the AVS-SEM (simultaneously extractable metals) analysis and aids comparison of results between sites.

4.3.2 Particulate organics

Analysis of many organic contaminants is a highly specialist activity, particularly when

dealing with many of the newer pesticides and chemicals such as those used in antifouling paints. Most organic analysis methods involve a preconcentration step (typically solvent extraction or solid phase adsorption) followed by separation and quantification by liquid or gas chromatography. Compound-specific detection is usually achieved by utilising coupled mass spectrometry or by some other specific detector. Many laboratories use in-house methods developed for a specific suite of organic contaminants. Guidance on sampling, storage and analysis should be sought directly from the analytical laboratory.

Detection limits (limits of determination, LOD) for organic contaminants vary greatly and are often dependent on the properties of the sediments and the presence of other contaminants (e.g. oils). Table 3 lists achievable detection limits for most common organic contaminants present in sediments. It is recommended that total organic carbon (TOC) analyses be made for the normalisation of organic contaminant concentrations to 1% TOC.

Oil and grease compounds are substances such as hydrocarbons, vegetable oils, animal fats, waxes, soaps, and greases. Oil and grease

concentrations are operationally defined depending on the solvent and the analytical method used. Petroleum hydrocarbons are oil and grease constituents that remain in solution after contact with silica gel, and may contain both aromatic hydrocarbons (e.g. PAHs, xylene, toluene, and benzene) and aliphatic hydrocarbons (methane, propane, and kerosene). Aromatic hydrocarbons are the most toxic compounds found in petroleum products.

Measurements of the bioavailable fraction of sediments have been undertaken using biomimetic methods designed to mimic the uptake and accumulation of organic contaminants from both water and sediment phases. These include the use of semi-permeable membrane devices (SPMDs), solid-phase microextraction fibres (SPMEs), polyethylene passive samplers, Tenax desorption techniques and gut fluid mimics (MacRae and Hall, 1998; Leppänen and Kukkonen, 2000; Cornelissen et al., 2001; Vinturella et al., 2004; Voparil and Mayer, 2004). Biomimetic devices are not substitutes for organisms, but provide complementary or preliminary information for toxicity testing, e.g. allowing a more efficient use of biota and a more refined understanding of toxicant exposure. The advantages and disadvantages of biomimetic devices have been discussed by Moore et al. (2004).

Both SPMDs and SPMEs are proving to be useful tools for measuring organic compounds in environmental matrices (Mayer et al., 2000; Echols et al., 2000; Petty et al., 2000; Verbruggen et al., 2000; Leppänen and Kukkonen, 2000). These devices selectively adsorb 'bioavailable' compounds and can concentrate them to very high levels in comparison to the surrounding matrix. Recently, Vinturella et al. (2004) demonstrated the use of passive samplers constructed from polyethylene (PEDs) to mimic the uptake of PAHs by benthic polychaetes. Tenax resins applied to sediment slurries have been found to provide good estimates of bioavailable organics (ten Hulscher et al., 2003). In this method, organic contaminants that rapidly desorb from sediments and exhibit linear

desorption kinetics are considered to be the bioavailable fraction. Resin desorption methods are simple to use and provide rapid estimates of bioavailable organics (Cornelissen et al., 2001; ten Hulscher et al., 2003).

Deposit-feeding and some suspension-feeding organisms accumulate many heavy metals and hydrophobic organic compounds via the ingestion of sediment (Lee et al., 2000a; Weston et al., 2000; Voparil et al., 2004); however, a proportion of most contaminants is not desorbed from the particles while in the gut, and passes out of the organism via the faeces (Wang and Fisher, 1999a). The bioavailability of particle-associated contaminants to deposit feeders can be estimated using digestive fluid extracted from organisms or digestive fluid mimics (Mayer et al., 1996; Chen and Mayer, 1999; Ahrens et al., 2001; Weston and Maruya, 2002; Voparil and Mayer, 2004). In these methods, sediments are incubated with the digestive fluid *in vitro* (or with the chemical surrogate) and the amount of the particle-associated contaminant that is desorbed in the fluid is then quantified on the presumption that sediment-associated contaminants must first be solubilised in order to be bioavailable. Because subsequent absorption of the solubilised contaminant across the gut wall is not addressed, the solubilised contaminant may still not be bioavailable, but the method does give an upper limit on the contaminant that is likely to be made bioavailable from a given sediment during gut passage (Weston and Mayer, 1998). Regression analyses of gut-fluid extracted contaminant concentrations versus bioaccumulated body burdens reveal strong positive correlations for a number of contaminants, suggesting that gut-fluid extractions might be considered as predictors of bioaccumulation (Lawrence et al., 1999; Weston and Maruya, 2002).

4.3.3 Contaminants in pore waters

Collecting sufficient pore waters is frequently a limitation, restricting analytes to those that have adequate detection limits on small volumes (<10 mL). Analyses of most

contaminants in pore waters is a highly specialist activity, particularly when dealing with saline waters.

Non-metal inorganics

Salinity may be an important parameter in the mixing zones of estuarine systems where tidal flushing causes large fluctuations in water salinity (Chapman and Wang, 2001). The most reliable method for determining the true or absolute salinity is by complete chemical analysis (Grasshoff et al., 1983). However, this is time consuming and costly and methods based on conductivity should be used. Conductivity measurements have the greatest precision.

Dissolved organic carbon (DOC) forms strong complexes with many metals and influences metal bioavailability (Di Toro et al., 2001). DOC is generally defined as the fraction of organic carbon that passed through a 0.45- μm filter. Sediment pore waters may have very high DOC concentrations, a considerable portion of which may be colloidal (Chin and Gschwend, 1991; Burdige and Gardner 1998; Sanudo-Wilhelmy et al., 2002). DOC is generally measured using combustion-infrared methods.

Ammonia is the most common porewater toxicant identified by toxicant identification evaluation (TIE) studies (Ho et al., 2002). The total ammonia concentration in a natural water is the sum of the two chemical species: ionised (NH_4^+) and unionised ammonia (NH_3). It is unionised ammonia that is primarily responsible for toxicity to aquatic organisms. The proportion of total ammonia that is present as unionised ammonia is pH and temperature dependent. The trigger values reported in the guideline documents (ANZECC/ARMCANZ, 2000a) are expressed as total ammonia. Analyses of ammonia are best undertaken using colorimetric analysis techniques with detection limits of approximately 10 $\mu\text{g/L}$. The ammonia-selective electrode method is appropriate when concentrations range between 0.03 and 1400 mg $\text{NH}_3\text{-N/L}$.

Cyanide can enter aquatic systems as CN^- , as undissociated hydrocyanic acid (HCN), and as a

range of complexes with iron (e.g. $\text{Fe}(\text{CN})_6^{3-}$ and $\text{Fe}(\text{CN})_6^{4-}$) or other metals. These complexes have varying stability (e.g. Zn, Pb, and Cd complexes dissociate in water while those of Ni, Cu and Ag are more stable). Methods are available for total cyanide, weak acid-dissociable cyanide (free cyanide + acid-dissociable complexes) and free cyanide. Undissociated HCN is the more toxic form, and the guidelines are expressed on this basis. At pH values between 6.5 and 8.0 (10-30°C water temperature), unionised cyanide is >92% of total cyanide, so this calculation and adjustment of the trigger value is of little practical significance. Porewater cyanide can be easily analysed using flow injection analysis (FIA). The detection limit of this method is 5 $\mu\text{g/L}$.

Hydrogen sulfide (unionised H_2S) is the more toxic form of aqueous sulfide, and the guidelines are expressed on this basis. The determination of hydrogen sulfide is difficult, so the usual analytical procedure involves colorimetric measurement of total sulfide and calculation of the fraction that is present as unionised H_2S . Porewater sulfide can be easily analysed using the colorimetric method described by Cline (1969). The detection limit of this method is 1-10 $\mu\text{g/L}$.

Metal (and metalloid) toxicants

Analyses of porewater metals to guideline concentrations are achievable by a number of techniques for freshwaters but substantially fewer techniques for saline waters. The analysis of trace metals in saline samples is a specialist activity, owing to the extensive interferences that can result from the high salt concentrations in the samples. Spectrometric analyses often involve a matrix separation (in order to avoid interferences from the saline matrix) and a pre-concentration step. These are normally simultaneous procedures, such as chelation/solvent extraction, or isolation using chelating ion exchange resins. High reagent purity and clean room laboratory techniques are vital in order to attain accurate results. These techniques are required to obtain sub $\mu\text{g/L}$ detection limits for metals in saline waters.

Direct analysis of metals in saline waters is possible for concentrations greater than 1 µg/L using combinations of ICPAES and high-resolution ICPMS (salt interference minimised by dilution). Detection limits are typically 10 times poorer than attained for freshwaters but may be suitable for monitoring some metals to the specified trigger value concentrations (e.g. for sediment elutriates). Vapour generation methods coupled with some form of atomic spectrometry are used to determine arsenic, mercury and selenium in both fresh and saline matrices.

Metal speciation in pore waters

Metals may exist in natural waters in a variety of chemical forms or species, including particles, colloids, complexes with natural organic matter, simple inorganic (and organic) complexes, and the free metal ion. The objective is to measure the physicochemical forms of a contaminant that actually contribute toward toxicity. Contaminants associated with colloids and particles are assumed to have low potential toxicity, as are metal complexes that form with natural dissolved organic matter (a constituent of all surface waters). Metal toxicity is assumed to be related to the concentration of simple inorganic metal species. Relevant speciation methods are therefore the ones able to discriminate simple inorganic metal species from colloids, particles and/or complexes with natural organic matter.

A further form of speciation analysis involves the discrimination between different oxidation states. Separate trigger values are given for each of the two oxidation states of arsenic and chromium (ANZECC/ARMCANZ, 2000a). This is because in each case there are marked differences in toxicity between these oxidation states, with As(III) generally more toxic than As(V), and Cr(VI) more toxic than Cr(III). In order to avoid unnecessary analytical costs, the pragmatic approach is to first measure total arsenic or total chromium concentrations and compare to the trigger values for the most toxic oxidation state (As(III) and Cr(VI)). If these values are exceeded, then specific determination of each oxidation state should be undertaken.

Methods for arsenic speciation involve separation, hydride generation and detection by some form of atomic spectrometry. Chromium speciation has been determined by a variety of methods including ion exchange separations, selective co-precipitation and determination by graphite furnace atomic absorption spectrometry (GFAAS), ICPAES or ICPMS.

The guidelines are not specific about measurement tools for speciation, because this is currently a specialist area undertaken by only a few laboratories. For the moment, many of the metal speciation techniques are not sufficiently robust for application in routine laboratories. It is anticipated that this situation will change in the next 3-4 years.

Organic contaminants

Trace organic analysis is a highly specialised area, and it is unlikely that this would be carried out for pore waters. Analyses of organics contaminants to guideline concentrations (water guidelines) require large volumes and are expensive. Most organic analysis methods involve a preconcentration step (typically solvent extraction or solid phase adsorption) followed by separation and quantification by liquid or gas chromatography. Compound-specific detection is usually achieved by utilising coupled mass spectrometry or by some other specific detector. Many laboratories use in-house methods developed for a specific suite of organic contaminants. Guidance on sampling, storage and analysis should be sought directly from the analytical laboratory.

It is recommended that porewater concentrations should be predicted using equilibrium partitioning (EqP) models (e.g. Di Toro et al., 1992):

$$C_p = C_s / (f_{oc} \times K_{oc})$$

where the organic chemical concentration in the pore water (C_p , µg/L) is calculated from its sediment concentration (C_s , µg/kg) based on the fraction of organic carbon (f_{oc}) in the same sediment ($f_{oc} = \%TOC/100$) and the organic carbon/water partition coefficient (K_{oc}) for the chemical. Values of K_{oc} can be estimated from

the relationship (Karickhoff et al., 1989):

$$\log_{10}K_{oc} = 0.00028 + 0.983 \times \log_{10}K_{ow}$$

where K_{ow} is the octanol/water partition coefficient (Di Toro et al., 2000).

Modifications to this relationship may be possible based on a better understanding of contaminant partitioning (e.g. presence of black carbon), but these measurements would be beyond most sediment assessment programs.

4.4 Background/Reference Data

The analysis of background concentrations of contaminants that occur naturally may be

important when study sites involve highly mineralised catchments. The theoretical background concentration of most synthetic organic compounds is zero. For metals, a reliable determination of 'natural' levels of contaminants is best made by analysing deep sediments (e.g. >1 m depth) deposited at the same location of the assessment site or at a range of uncontaminated sites of close locality and similar geology as the site being assessed. It is important to only compare sediments that have similar grain size distributions, as particle size greatly affects the distribution of contaminants.

5 SEDIMENT ECOTOXICOLOGY

5.1 Introduction

This section deals with toxicity testing of sediments. Current whole-sediment tests in use in Australia are largely acute tests that measure invertebrate survival (e.g. King et al., 2006b) and algal enzyme response (Adams and Stauber, 2004). A listing of those in common use for estuarine and marine sediments is provided in Table 4. There are few whole-sediment tests available for freshwater sediments using local species, largely because the demand has been not as great as for marine whole-sediment tests. More detailed

protocols are provided in Appendices 4-7, for acute marine sediment toxicity tests using a benthic alga (*Entomoneis punctulata*), amphipod (*Melita plumulosa*), bivalve (*Tellina deltoidalis*), and polychaete worm (*Australonereis ehlersi*).

Chronic tests are urgently required, particularly for the evaluation of dredged sediments for ocean disposal (Environment Australia, 2002). The guidelines for dredged spoil disposal require testing of chronic toxicity of sediments if no acute toxicity is found, yet few chronic tests are currently

Table 4. Whole-sediment estuarine and marine toxicity tests

Type	Test Species	Endpoint	Acute/ Chronic	Temperate/ Tropical	Reference
Bacterium	<i>Vibrio fischeri</i> (Microtox)	15-min luminescence	Acute	Temperate	Environment Canada, 2002
Microalga	<i>Entomoneis punctulata</i>	72-h growth	Chronic	Temperate	Adams and Stauber, 2004
Amphipod	<i>Melita plumulosa</i>	10-day survival	Acute	Temperate	King et al., 2006b
Amphipod	<i>Melita plumulosa</i>	28-42-d reproduction	Chronic	Temperate	Gale et al., 2006
Amphipod	<i>Grandidierella japonica</i>	10-d survival	Acute	Temperate	Tsvetnenko et al., 2000
Amphipod	<i>Grandidierella japonica</i>	28-d growth	Chronic	Temperate	Black, 2003
Amphipod	<i>Corophium colo</i>	10-d survival and emergence	Acute	Temperate	Hyne and Everett, 1998
Amphipod	<i>Corophium colo</i>	14-d growth	Chronic	Temperate	Surtikanti and Hyne, 2000
Amphipod	<i>Corophium insidiosum</i>	10-d survival	Acute	Temperate	Adams et al., 2001
Crab	<i>Diogenes</i> sp.	10-d survival	Acute	Tropical	Black, 2003
Bivalve	<i>Tellina deltoidalis</i>	10-d survival	Acute	Temperate	King et al., 2006c
Bivalve	<i>Paphies elongata</i>	10-d survival	Acute	Temperate	Black, 2003
Bivalve	<i>Paphies elongata</i>	28-d growth	Chronic	Temperate	Black, 2003
Bivalve	<i>Donax cuneata</i> and <i>Donax columbella</i>	10-d survival	Acute	Temperate/ tropical	Black, 2003
Polychaete worm	<i>Australonereis ehlersi</i>	10-d survival	Acute	Temperate	Stokie et al., 2004
Polychaete worm	<i>Ceratonereis aequisetis</i>	10-d survival	Acute	Temperate	Black, 2003
Polychaete worm	<i>Scoloplos</i> sp.	10-d survival	Acute	Tropical	Black, 2003

available. One of the few available is a test based on reproduction in the amphipod *M. plumulosa* over 6 weeks, developed recently by Gale et al. (2006). Continued research into the development of sediment toxicity methods, particularly chronic tests, and their application to evaluate the relative sensitivity of endpoints, refine sediment toxicity identification evaluation (TIE) procedures, and comparison to responses with natural populations of benthic organisms (ecological data) will be expected to result in a significant number of other 'standardised test methods' becoming available in the future.

5.2 Selection of Organisms for Toxicity Tests

The test organism used will have a major influence on the outcome of the tests. No one organism is best suited for all sediments and generally, a range of organisms, with differing exposure pathways, should be used for ecotoxicological assessment of contaminated sediments.

The following criteria have been set out in the ASTM (2003) guide for 'measuring the toxicity of sediment-associated contaminants with estuarine and marine invertebrates'. Ideally, a test organism should:

- (i) have a toxicological database demonstrating relative sensitivity to a range of contaminants of interest in sediment,
- (ii) have a database for interlaboratory comparisons of procedures (for example, round-robin studies),
- (iii) be in direct contact with sediment,
- (iv) be readily available from culture or through field collection,
- (v) be easily maintained in the laboratory,
- (vi) be easily identified,
- (vii) be ecologically or economically important,
- (viii) have a broad geographical distribution, be indigenous (either present or historical) to the site being evaluated, or have a niche similar to organisms of

concern (for example, similar feeding guild or behaviour to the indigenous organisms),

- (ix) be tolerant of a broad range of sediment physico-chemical characteristics (for example, grain size),
- (x) be compatible with selected exposure methods and endpoints,
- (xi) be used as part of peer-reviewed methods (e.g. journal articles),
- (xii) have its response confirmed with responses with natural populations of benthic organisms (ASTM, 2003).

Although few test species in use worldwide meet all of these criteria, they should be considered carefully when planning sediment quality assessments. A very important consideration for sediment quality assessments is a proven sensitivity of test species to the contaminants of concern and knowledge of the route of exposure, as exposure pathways are readily affected by sample handling techniques.

5.2.1 Contaminant exposure pathways

Sediment-dwelling organisms receive contaminant exposures from four sources: overlying water, pore waters, sediment particles, and food (e.g. algae, other organisms). Food type and availability, feeding rate, and assimilation efficiency, all affect contaminant influx rates, which together with excretion rates, ultimately control the net uptake of contaminants from sediment (Wang, 2002; Wang and Ke, 2002). Sediment quality assessments are likely to be more effective if they are built upon knowledge of from where and in what manner animals take up contaminants (Hare et al., 2003). Ignoring food as a metal source could severely underestimate metal exposures for some organisms.

Bioenergetic-based kinetic models that describe copper bioaccumulation by the Australian amphipod, *M. plumulosa*, and bivalve, *T. deltoidalis*, have highlighted the importance of the partitioning of copper between the sediments and waters (K_d), and

organism feeding behaviour (ingestion rates, selective feeding) in controlling the total copper exposure these organisms would receive during whole-sediment toxicity tests (King et al., 2005).

The identification of causality in whole-sediment toxicity tests using benthic organisms can be greatly aided by combining knowledge of effect concentrations and contaminant bioaccumulation following water and sediment exposures with knowledge of contaminant exposure pathways. Recent studies indicate that copper accumulation by *M. plumulosa* and *T. deltoidalis* from sediment ingestion may cause effects (acute toxicity) in these organisms in the same manner as copper accumulation from water exposures (Simpson and King, 2005). The sediment copper concentrations required for toxicity to occur are, however, well above current interim SQG values. These models also indicate that a large range of effects concentrations may be measured for sediments with the same total copper concentration. These are conditional effect concentrations, as their value will be determined by total copper concentrations, partitioning (K_d) relationships (sediment properties), organism physiology (uptake rates from waters, assimilation efficiencies from solids), and organism feeding behaviour (feeding selectivity).

Although no specific guidance can currently be given for individual test species, we suggest that integrating the complexities associated with exposure pathways into laboratory tests and sediment quality assessment protocols will improve their meaningfulness and thus their ability to protect aquatic ecosystems.

5.2.2 Porewater exposure

The toxicity and bioaccumulation of many non-ionic organic contaminants in sediments (e.g. PAHs and OC pesticides) and some metals often show good correlation with the porewater concentration of these contaminants (Di Toro et al., 1990; Di Toro et al., 1991; Ankley et al., 1996). Because porewater concentrations of both metals and organics are generally difficult to measure, equilibrium-partitioning (EqP) relationships are often used to estimate

porewater concentrations, to aid the development of these relationships.

The relative importance of whole sediment and interstitial water routes of exposure depends on the test organism and the specific contaminant (Knezovich and Harrison, 1987). Because benthic communities contain a diversity of organisms, many combinations of exposure routes may be important. Therefore, behaviour and feeding habits of a test organism can influence its ability to accumulate contaminants from sediment and should be considered when selecting test organisms for sediment testing.

5.2.3 Toxicity modifying factors

Partitioning or sorption of a compound between water and sediment may depend on many factors including: aqueous solubility, pH, redox, affinity for sediment organic carbon and dissolved organic carbon, grain size of the sediment, sediment mineral constituents (oxides of iron, manganese, and aluminium), and the quantity of AVS in sediment. Although certain chemicals are highly sorbed to sediment, these compounds may still be available to the biota. Chemicals in sediments may be directly toxic to aquatic life or can be a source of chemicals for bioaccumulation in the food chain.

The objective of a sediment test is to determine whether chemicals in sediment are harmful to or are bioaccumulated by benthic organisms. The tests can be used to measure interactive toxic effects of complex chemical mixtures in sediment. Furthermore, knowledge of specific pathways of interactions among sediments and test organisms is not necessary to conduct the tests. Sediment tests can be used to:

- (i) determine the relationship between toxic effects and bioavailability,
- (ii) investigate interactions among chemicals,
- (iii) compare the sensitivities of different organisms,
- (iv) determine spatial and temporal distribution of contamination,

- (v) evaluate hazards of dredged material,
- (vi) measure toxicity as part of product licensing or safety testing,
- (vii) rank areas for clean up, and
- (viii) estimate the effectiveness of remediation or management practices.

Evaluating effects concentrations for chemicals in sediment requires knowledge of factors controlling their bioavailability. Similar concentrations of a chemical in units of mass of chemical per mass of sediment dry weight often exhibit a range in toxicity in different sediments. Effects concentrations of chemicals in sediment have been correlated to interstitial water concentrations, and effects concentrations in interstitial water are often similar to effect concentrations in water-only exposures. The bioavailability of non-ionic organic compounds in sediment is often inversely correlated with the organic carbon concentration. Whatever the route of exposure, these correlations of effect concentrations to porewater concentrations indicate that predicted or measured concentrations in pore water can be used to quantify the exposure concentration to an organism. Therefore, information on partitioning of chemicals between solid and liquid phases of sediment is useful for establishing effect concentrations.

Where sediment disturbances are suspected of altering contaminant bioavailability, some discussion should be included on the effects of sample manipulation on contaminant bioavailability and the outcome on the toxicity test results (e.g. if AVS decreased, then metals may have been more bioavailable in the manipulated sediments).

5.3 Quality Assurance

5.3.1 Control sediments

Sediment tests should include a control sediment (sometimes called a negative control) that is essentially free of contaminants and is used to assess the acceptability of the test, to provide evidence of test organism health, and as a reference point for interpreting effects from the test

sediments. Two types of control sediments can be used:

- (i) natural field-collected sediments, and
- (ii) prepared sediments such as artificial or formulated sediments.

Control sediments should be collected from any uncontaminated site and their physico-chemical properties such as grain size, TOC, AVS and background levels of trace elements determined. Porewater pH, salinity, metal and ammonia concentrations of the control sediments should also be determined. If field-collected control sediments are used, they should be stored at 4°C in sealed containers for no longer than 12 months.

Artificial control sediments have not been routinely used in Australasia in marine whole-sediment tests. Details of several formulations and procedures for their preparation are given in Environment Canada (1995).

5.3.2 Reference sediments

Reference sediments collected from sites near the contaminated site may be used to assess effects due to sediment conditions exclusive of contaminants present at the contaminated site. The use of reference sediments provides a site-specific basis for evaluating the effects data. Reference sediments are critical for interpreting toxicity tests as parallel tests with reference sediments can help estimate the relative contributions of natural and anthropogenic toxicants.

5.3.3 Reference toxicants

A reference toxicant is a chemical that is used in toxicity testing to make comparisons between inter- or intra-laboratory test results. Reference toxicants provide a general measure of the reproducibility (precision) of a toxicity test method over time. If individual test results fall outside established limits (LC50 ± 2 standard deviations), an investigation into the source of the variability is triggered. Inclusion of a reference toxicant in each toxicity test enables variability in organism health, different batches of test organisms, differences in laboratory water quality and

operational consistency of testing personnel to be determined (Environment Canada, 1990).

For sediment tests, reference toxicants may be used in either water-only exposures or in spiked sediment tests. Because of the ease of conducting water-only exposures and the relative speed with which results can be obtained, reference toxicant tests using water-only exposures have traditionally been used in conjunction with whole-sediment tests (Environment Canada, 1992a,b). A 4-day static LC50 test, using a range of concentrations of cadmium in seawater (no sediment) has routinely been used as a reference toxicant alongside marine amphipod 10-day acute whole-sediment tests (Paine and McPherson, 1991, Environment Canada, 1992a).

When conducting a seawater-only 96-h acute reference toxicant test, test conditions and test procedures must be identical to those used in the whole-sediment test, except that sediment is not added to the test vessel. Replication may be reduced but Environment Canada (1992a) recommends the use of 10-20 organisms at each of five reference toxicant concentrations. The test should be initiated using the same batch of test organisms and within one day of commencing the 10-day whole-sediment test.

Selection of reference toxicants depends on the test organism, its known sensitivity under a range of pH and salinity conditions, a well-defined dose-response curve for that chemical, and the availability of analytical techniques to determine measured concentrations. Reagent-grade cadmium (as cadmium chloride) and copper (as copper sulfate) have been widely used (Cairns et al., 1984; Swartz et al., 1985). If an organic reference toxicant is required, fluoranthene is recommended by Environment Canada (1992a).

For chronic whole-sediment tests, such as those based on growth and reproduction, reference toxicant tests using spiked sediments rather than water-only exposures are recommended. Reference toxicants recommended by Environment Canada (1995) are copper and fluoranthene. A control sediment (either a natural sediment of known physico-chemical characteristics or an

artificially-formulated sediment) should be spiked with the reference toxicant using similar procedures to those outlined in Section 3.4.4. All exposure concentrations should be prepared by directly spiking the sediment, not by diluting the sediment mixture with a 'clean' sediment. Reference toxicant concentrations in both the spiked sediment and pore water taken from high, medium and low test concentrations and from controls should be measured at the beginning and end of the test.

Further details about the use of spiked sediments in reference toxicant tests and interpretation of reference toxicant control charts are given in the Environment Canada (1995) guidance document.

5.3.4 Test organism handling and acclimation

Whether sourced from field collections or cultures, organisms of similar life stage, age and size should be used in the sediment toxicity tests.

Generally, field-collected invertebrates are transported in containers with a 2-4 cm layer of sieved sediment and overlying water from the collection site. For amphipods, the density should not exceed 1 amphipod/cm² (Environment Canada, 1998). Field-collected organisms must be acclimated to laboratory testing conditions for 2-10 days before test commencement, with regular replacement of overlying water to maintain sufficient dissolved oxygen. If salinity adjustment is required, this should be done slowly, allowing at least a day for acclimation at each salinity (2‰ incremental increase), until the desired test salinity is reached.

Any dead organisms or organisms that behave atypically should be removed and discarded prior to the toxicity test.

5.3.5 Criteria for test validity

The criteria for determining test validity (specific to each toxicity test species) are an essential component of good quality assurance procedures. For 10-day acute invertebrate

whole-sediment tests, survival in the controls would normally have to be at least 90%. In addition, water quality parameters such as pH, salinity, DO and temperature should be within set limits. Reference toxicant tests using either water-only exposures or spiked sediments should give LC50 values within ± 2 SDs of the mean value from running quality control charts specific to that test organism and test conditions. For longer-term chronic tests, an 80% criterion is considered acceptable for survival and separate performance-based criteria should be given for other effects measures (e.g. growth or reproduction) in controls (ASTM, 2003).

5.4 Sediment Toxicity Tests

5.4.1 Selection of appropriate tests

Historically, the evaluation of contaminants in sediments has focused on testing sediment elutriates and pore waters, using aquatic test species. In general, elutriate tests are not recommended, except for assessing the release of contaminants from dredged sediments as part of the assessment process of sediments for ocean disposal. Solvent extracts of sediments are also not recommended due to their lack of environmental relevance. Solvents can mobilise particle-bound toxicants that would not otherwise be bioavailable *in situ*, and the toxicity of the solvent itself may confound test results (Environment Canada, 1999).

Porewater tests have been widely used as it is often assumed that contaminants in sediments are in equilibrium with pore waters. Carr (1998) reviews the advantages of porewater tests, suitable species and practical considerations. However, porewater chemistry may be altered during its extraction from sediments. Porewater tests can both overestimate metal toxicity due to oxidation of sulfides which would otherwise bind metals, or underestimate toxicity if metals are co-precipitated with iron during extraction (Environment Canada, 1999; Simpson and Batley, 2003; Chapman et al., 2002b). In addition, many benthic species ingest sediments and this dietary route of exposure

to contaminants is not measured in porewater tests.

Recent emphasis has been on the development of whole-sediment toxicity tests with benthic species that live on and burrow in sediments. Most tests are acute tests (usually 10 days) that determine the survival of the test organism in contaminated sediment. However, there is an increasing need for chronic tests that measure either growth or reproduction over longer periods. For assessment of dredged sediments for ocean disposal in particular, chronic toxicity must be determined if no acute toxicity of sediments is found. Currently, chronic tests with amphipods and bivalves are not sufficiently developed in Australia to be suitable for regulatory purposes, although they are in use in North America (e.g. ASTM, 2003).

Similar to aquatic test species, different benthic species have different sensitivities to different toxicants. It is therefore important in sediment quality assessments to use a suite of tests with organisms having different feeding strategies and behaviours, to cover all potential routes of exposure. These may include a benthic alga living at the sediment-water interface (water route), an epibenthic deposit feeder, e.g. amphipod (sediment ingestion), a burrowing amphipod (water and sediment uptake), a benthic bivalve (water and sediment uptake) and a polychaete worm (sediment ingestion) (Figure 2; Table 4). If dredged sediment is being assessed, porewater tests with microalgae and sea urchin larvae may be appropriate, together with tests using biota in the presence of sediment particles.

The type of sediment collected for toxicity testing depends on the study aims. For most monitoring and toxicity assessment studies where historical contamination is not an issue, the upper 0-5 cm of sediment is the horizon of interest. Most infaunal organisms are found in the upper 10 cm (except for deep burrowers) and various grab sampling devices are discussed in Section 3 and in Environment Canada (1994). Alternatively, sediment cores can be collected and either homogenised or sectioned to provide sediment at a particular depth for toxicity testing. Whatever sampling method is used, anoxic sediments will be

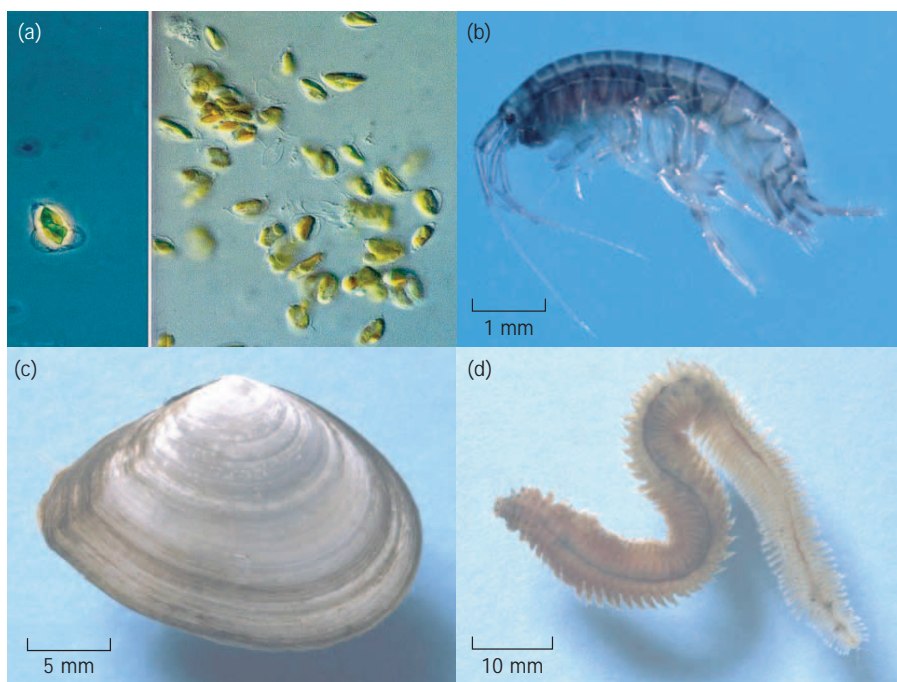

Figure 2. Species used for whole-sediment estuarine and marine toxicity testing: (a) the benthic alga *Entomoneis punctulata*, (b) the amphipod *Melita plumulosa*, (c) the bivalve *Tellina deltoidalis*, and (d) the polychaete *Australonereis ehlersi*

oxidised during collection, transport and preparation (e.g. sieving, aeration) for toxicity testing (Simpson and Batley, 2003). Oxidic sediments are appropriate for toxicity testing as most sediment infauna reside in the top oxic layer or irrigate their burrows with oxygenated overlying water.

5.4.2 Bacteria

The Microtox[®] toxicity test (Azur Environmental) determines the decrease in light output of the luminescent marine bacterium *Vibrio fischeri* after a 20-min exposure to sediments compared to unexposed controls. When properly maintained, naturally luminescent bacteria divert about 10% of their metabolic energy to a metabolic pathway that converts chemical energy, through the electron transport system, into visible light. This pathway is intrinsically linked to the respiration of the cell. A change in cellular metabolism or a disruption of the cellular structure results in a change in respiration and a concomitant change in bioluminescence (Ross, 1993). This toxicity test is a rapid acute test that is commercially available as a test kit

with standard testing protocols for solid-phase samples (Azur Environmental, 1998). Bacteria are exposed to various concentrations of the test sediment and the resulting light output at each concentration is measured to obtain a concentration-response curve from which the EC50 value (effective concentration of sediment to cause a 50% reduction in light output) can be calculated.

Prior to bacterial light measurements in the standard Microtox[®] bioassay, the sediment/ bacteria vial is filtered to remove the interferences of sediment particles. Filtering can remove bacteria adsorbed to sediment particles and this is particularly a problem with fine (<63 µm) sediments, that have a large surface area for bacteria binding. The decrease in light output may be due to removal of bacteria, rather than due to true toxicity of the sample (false positive). Additional sources of interference in light output measurements include the absorption of light due to the colour of the test solution after filtration and the scattering of light due to turbidity. While Day et al. (1995) found a correlation between toxicity detected from

Microtox[®] bioassays and benthic invertebrate tests (using amphipods), many authors have found that Microtox[®] bioassays give confounding and highly variable toxicity results due to these problems (Cook and Wells, 1996, Côte et al. 1998). The use of a reference sediment is one way to overcome some of these problems. Thus, selecting the appropriate reference sediment with the same particle size distribution, colour and turbidity as the test sediment is crucial for interpreting results obtained using the Microtox[®] test.

Sediments with a wide range of physico-chemical parameters can be tested with *V. fischeri*. Sediments from freshwater environments can also be tested with saline water, but the environmental relevance of this procedure is questionable. The Microtox[®] test has well established and standardised published protocols and due to the simplicity and rapid nature of the test, it is commonly used worldwide and is a useful tool for screening and ranking a large number of sediments to quickly identify areas of concern. It should, however, never be used alone for decision making.

5.4.3 Algae

Benthic algae (microphytobenthos) play an important role in stabilising sediments, providing habitat, modulating chemical transformations and remobilising metals at the sediment-water interface. Despite their importance in sediment ecosystems, the development of whole-sediment tests with microalgae has been limited by the ability to distinguish and count algae in the presence of sediment particles. For this reason, tests based on growth rate (where cells are counted daily by microscope) have rarely been attempted (Moreno-Garrido et al., 2003). Because of these difficulties, other endpoints apart from growth inhibition, such as algal photosynthesis and enzyme activity have been used in developing freshwater sediment tests (Munawar and Munawar, 1987; Blaise and Menard, 1998).

A whole-sediment toxicity test suitable for estuarine or marine environments using the marine benthic alga *Entomoneis cf. punctulata*

is now routinely used in Australia (Figure 2; Appendix 4). The unicellular benthic marine alga *Entomoneis* sp. (strain no. CS-426) was obtained from CSIRO Marine Research, Hobart (Tasmania, Australia). *Entomoneis* sp. was originally isolated from Little Swanport (42°20':147°56'), on the east coast of Tasmania by Richard Knuckey in 1995. The isolate was identified as *Entomoneis cf. punctulata* Osada et Kobayashi (CS-426) by Dr Gustaff Hallegraef (University of Tasmania, Australia).

This test determines the acute toxicity of sediments following a 3- or 24-h exposure. The test endpoint is enzyme (esterase) activity measured by flow cytometry, which has the ability to distinguish algal cells from sediment particles based on their chlorophyll *a* autofluorescence. Enzyme activity, rather than growth rate, is used as the test endpoint as nutrient release from sediments has previously been shown to stimulate algal growth, potentially masking contaminant toxicity (Hall et al., 1996). Esterase activity has been regarded to indicate cell viability in plant and algal cells (Dorsey et al., 1989; Steward et al., 1999; St-Laurent and Blaise, 1995).

Entomoneis cf. punctulata has been shown to be tolerant to a wide range of physico-chemical parameters including salinity (15-35‰), pH (6.5-8.5) and particle size (0-100% fines <63 µm). This test is relatively sensitive to copper (3-h IC₅₀ of 97 ± 39 µg Cu/L), but was not sensitive to other metals such as cadmium, lead, manganese or zinc (Adams and Stauber, 2004). The primary route of exposure to copper, from copper-contaminated mine tailings material, is via pore water rather than by direct contact with tailings particles (Adams and Stauber, 2004). In contrast, the alga is sensitive to PAH-contaminated sediments with concentrations greater than 30 mg total PAH/kg dry weight causing significant inhibition in algal esterase activity (Stauber et al., 2004) (within the ANZECC/ARMCANZ (2000a) ISQG-Low and -High values of 4 and 45 mg/kg dry weight) suggesting that this test will be useful for assessing suitability of dredged sediments for ocean disposal.

As well as the whole-sediment toxicity tests, toxicity tests that measure the esterase

activity or growth rate over 72-h (a chronic test) as the test endpoint can also be successfully carried out on pore waters, overlying waters and elutriates.

5.4.4 Amphipods

There are a number of endemic Australian estuarine/marine amphipod species that are available for use as test species in whole-sediment toxicity tests, e.g. *Corophium colo*, *Grandidierella japonica*, *Chaetocorophium cf. lucasi*, *Melita plumulosa*, *Melita matilda*, *Hyale crassicornis*, *Hyale longicornis* (King et al., 2006a; Black et al., 2005; Lowry, 2004). *Corophium colo*, *G. japonica*, and *C. cf. lucasi* are infaunal filter feeding species, living in U-shaped burrows in the top 3 cm of sediment. In contrast, *M. plumulosa*, *M. matilda*, *H. crassicornis* and *H. longicornis* are epibenthic deposit feeding species, living at the sediment water interface underneath rocks or shell grit. All species inhabit both estuarine and marine areas, with some species, including *C. colo* and *M. plumulosa* also extending into freshwaters. While they are most common in intertidal areas, most species are known to exist in the entire littoral zone from 0-25 m depth (Lowry et al., 2000; Lowry and Stoddart, 2003).

Corophium colo and *M. plumulosa* have been most frequently used for whole-sediment toxicity tests. *Grandidierella japonica* has also been used as a test species in Western Australia. A comparison of the sensitivity of these amphipod species to copper and zinc in water-only exposures and standard 10 d whole-sediment tests indicated that *M. plumulosa* was the most sensitive of these species to metal contaminants (King et al., 2006a). Additional studies are being undertaken to better evaluate the sensitivity of these species to metal and organic contaminated sediments and further develop both acute and chronic toxicity tests with these species. A series of tests using different amphipod species will always provide greater information than results from using a single species. *Melita plumulosa* is an epibenthic deposit feeder that lives in close association with sediments with permanent burrows, while *C. colo* is an

infaunal species that creates permanent burrows. The differences in the burrowing behaviour of these two amphipods will influence the importance of the exposure to contaminants that these species receive from water, sediments and food sources.

Corophium colo is very sensitive to selenoaminoacids (Hyne et al., 2002), but generally less sensitive to heavy metals such as copper (Hyne and Everett, 1998). Whole-sediment tests with *C. colo* were more predictive of sediments contaminated with heavy metals exceeding guideline values, than sediments contaminated with PAHs in Sydney Harbour (McCready et al., 2004).

Melita plumulosa (Family Melitidae) (Figure 2, Appendix 5) is commonly found in estuarine tidal mud-flat areas ranging from silty to sandy sediments in freshwater, estuarine and marine environments throughout south-eastern Australia. *M. plumulosa* is an epibenthic deposit feeding amphipod, living in close association with sediments, using the sediment as both a home and a food source. It is an important source of food for higher trophic levels. It inhabits a wide variety of surroundings from intertidal seagrass beds to muddy sand, up to a water depth of 25 m. Males grow to an approximate length of 7 mm, and females to a length of 5 mm (Lowry et al., 2000). *Melita plumulosa* have two pathways of exposure to contaminants: by direct diffusion of organic contaminants across their gills or by ingestion of particles to which toxicants may be adsorbed. Ingestion of particulate sediment is a major pathway for metal contaminants.

Corophium colo (Family Corophiidae; previous known as *Corophium cf. volutator* or *Corophium sp.*) is an infaunal sediment dwelling corophiid amphipod (Lowry et al., 2000; Lowry, 2004), is abundant in fresh and estuarine tidal sections of the Hawkesbury River catchment in NSW (Jones et al., 1986; Hyne and Everett, 1998). The amphipod is typically found 1-5 cm below the sediment surface, in the intertidal zones of river banks which are vertical, of solid structure, low sand content, with abundant macrophyte growth and water in the range 0.1-24%. These amphipods build U-shaped burrows in sediment

consisting of fine sand mixed with clays. Females of *C. colo* with body lengths greater than 8 mm were considered sexually mature as no gravid individuals were observed below this size. The average maximum body length of females was 13.1 mm and that of males was 11.6 mm (Surtikanti et al., 1998; Surtikanti and Hyne, 2000). Organic detritus, bacteria and diatoms are their main food components. *Corophium colo* normally only feed in their burrows, obtaining food by moving their appendages to create a water current from the sediment surface. Hence sediment pore water is an important pathway of exposure of *C. colo* to contaminants together with some ingestion of particles to which toxicants may be adsorbed.

Grandidierella japonica (Family Gammaridea) is an infaunal tube dweller that inhabits the upper 3 cm of a wide variety of sediment types from silty to sandy sediments in marine and estuarine environments throughout the temperate region of Western Australia. The amphipod is a sediment scavenger, feeding on algae and organic detritus present in the sediment and it performs sediment bioturbation via its burrowing and irrigating habits. They are an important source of food for juveniles of many marine species in higher trophic levels. The amphipod inhabits sandy and muddy sediments up to a depth of 50 m on the North West Shelf. *Grandidierella japonica* is a recognised ecotoxicity test animal (ASTM, 1992) and has been used for sediment toxicity assessment in Western Australia, Japan, and California (USA). Males grow to an approximate length of 15 mm, and females to a length of 12 mm. *Grandidierella japonica* have two pathways of exposure to contaminants: by direct dermal contact with contaminants or by ingestion of particles to which toxicants may be adsorbed. Ingestion of particulate sediment is a major pathway for metal contaminants.

As already noted, chronic toxicity tests are currently being developed using the amphipod *M. plumulosa* (Gale et al., 2005). These tests involve 6-week exposure periods and use survival, growth, and reproduction of amphipods as test endpoints.

5.4.5 Bivalves (Clams)

Several endemic Australian estuarine/marine bivalves have been investigated as test species in whole-sediment toxicity tests. A comparison of the sensitivity of the bivalves *Tellina deltoidalis*, *Mysella anomala*, *Soletellina alba*, indicated that *T. deltoidalis* would be the most useful test species and was sensitive to sediment copper (King et al., 2004). The bivalve *Paphies elongata* has been used by Black et al. (2005) for whole-sediment tests in Western Australia.

Tellina deltoidalis (Family Tellinidae) (Figure 2; Appendix 6) lives in estuarine and coastal lagoons from southern Queensland to Tasmania and in south Western Australia, Australia. *Tellina deltoidalis* grows to approximately 25 mm in length, and although the biology of this species has not been studied, it is presumably a deposit feeder like other tellinids, collecting organic material and particles from surface sediments. It is thought to reproduce by broadcast spawning with planktotrophic larvae (Willan, 1998; Ponder et al., 2000; King et al., 2006c).

Mysella anomala (Family Galeommatidae) is a common bivalve found in estuaries and coastal areas in NSW, Australia (Ponder, 1998; Ponder et al., 2000). It grows to a length of approximately 20 mm, and is a shallow burrower to depths of up to 10 cm. The biology of this species has not been studied but it is thought to be free living. Like other members of this family, it feeds by filtering suspended particles from overlying waters and the larvae are brooded within the shell (Ponder, 1998; Ponder et al., 2000).

Soletellina alba (Family Psammobiidae) is endemic to Australia, inhabiting estuaries and sheltered bays from mid Queensland to South Australia. The thin and fragile shell of *S. alba* grows to a length of 50 mm, and this species burrows up to depths of 300 mm. The biology of this species has not been studied but it appears to filter feed on particulate matter, collected from the overlying water using its long inhalant siphon, which can protrude well above the surface of the sediment (King, pers.

obs.). It may also deposit-feed on sediments and detritus, and probably reproduces by broadcast spawning with planktotrophic larvae (Ponder, 1998; Willan, 1998; Ponder et al., 2000).

Paphies elongata (Family Mesodesmatidae) is a small white triangular-shelled bivalve covered by a brown periostracum. It is a common inhabitant of sandy surf beaches ranging from temperate Western Australia through to Tasmania and southern NSW. *Paphies elongata* grows to approximately 16 mm in length and is a benthic filter feeder, collecting organic material and particles from the water column immediately above the sediment surface. The bivalve is known to rapidly burrow into the sand when disturbed (Beesley et al., 1998) and is exposed to contamination via dermal contact, by direct diffusion of organic contaminants across their gills or by ingestion of particles to which toxicants may be adsorbed.

Donax cuneata and *Donax columbella* (Family Donacidae) are small white triangular shelled bivalves covered by a various coloured periostracum. The bivalves are common inhabitants of sandy surf beaches throughout Australia with *D. cuneata* inhabiting tropical climates and *D. columbella* inhabiting temperate climates. Both *D. cuneata* and *D. columbella* both grow to approximately 35 mm in length and are benthic filter feeders, collecting organic material and particles from the water column immediately above the sediment surface. The bivalves are known to rapidly burrow into the sand when disturbed (Beesley et al., 1998) and are exposed to contamination via dermal contact, by direct diffusion of organic contaminants across their gills or by ingestion of particles to which toxicants may be adsorbed.

5.4.6 Polychaete worms

A whole-sediment toxicity test procedure has been developed using juveniles polychaetes, *Australonereis ehlersi* (Figure 2, Appendix 7) (Storkie et al., 2004). Studies by these workers have indicated that the adults of the polychaete worms species *A. ehlersi* and

Nephtys australiensis were found to be very difficult to handle in the laboratory and insensitive to metal contaminants in waters and sediments King et al. (2004). The polychaete worm *Ceratonereis* sp. has been used in Western Australia for whole-sediment tests by Black et al. (2005).

Australonereis ehlersi (Family Nereididae) is common in estuarine and coastal areas throughout the southern region of Australia from Western Australia to Queensland. It forms a series of deep (up to 40 cm), mucus-lined burrows in which it lives. It is predominantly a deposit feeder, ingesting sediment particles and detritus, although it also has carnivorous attributes, with an eversible pharynx and a pair of jaws (Glasby et al., 2000). It grows to a length of 20 cm, completes its life cycle within 1 to 1.5 years, and is thought to reproduce by epitoky and/or brooding of eggs in burrows (Glasby et al., 2000).

Nephtys australiensis (Family Nephthyidae) is common and endemic to estuarine areas in south-eastern Australia. This species grows to a length of 7 cm and burrows to a depth of at least 20 cm. It is free living within the sediment and does not form permanent tubes (King, pers. obs.). No studies of the biology of nephtyids in Australia have been undertaken. Like the majority of nephtyids, it is thought to feed primarily as a predator on small molluscs, crustaceans and other polychaetes. It may also feed on deposited sediments in the subsurface layer when prey items are scarce (Glasby et al., 2000). This species is likely to reproduce by broadcast spawning, external fertilisation of gametes and planktonic development of larvae in the water column (Glasby et al., 2000).

Ceratonereis aequisetis (Family Nereididae) is an elongated, cylindrical worm with a highly segmented body. It is commonly found in a wide range of marine sediments from shallow inertial mud-flats to 50 m on the North West Shelf. It belongs to the largest of the annelid class and is known to inhabit sediments throughout Australian marine environments. *Ceratonereis aequisetis* is a benthic deposit feeder, collecting organic material and

particles from the sediment and commonly burrowing below the sediment surface. Polychaete worms have haemoglobin with a high oxygen affinity that enables the worm to survive in anoxic sediments and feed on the organic sediment detritus (Beesley et al., 2000). It is exposed to contamination via dermal contact, by direct diffusion of organic contaminants or by ingestion of particles to which toxicants may be adsorbed.

5.5 Porewater and Elutriate Toxicity Tests

A range of tests for use in evaluating the toxicity of estuarine and marine sediment pore waters and elutriates is shown in Table 5. Few freshwater sediment tests are in common use, and toxicity testing of such sediments is often restricted to their pore waters or elutriates.

5.6 Overseas Test Species

There is now a wide range of standard toxicity test methods using estuarine or marine invertebrates found within North American coastal waters (ASTM, 2003). While some of these tests are well developed (e.g. 10-day acute toxicity tests using amphipod species), like the tests available in Australia, most tests still require further development. Tests with the amphipod species *Ampelisca abdita*, *Eohaustorius estuarius*, *Leptocheirus plumulosus* and *Rhepoxynius abronius* are well developed. Other amphipod species (e.g. *Corophium volutator*, *Grandidierella japonica*) are also being developed as test species. It is recommended that recent ASTM, Environment Canada and USEPA methodology documents be consulted prior to consideration of the use of overseas test species (e.g. ASTM, 2003).

Table 5. Toxicity tests for estuarine and marine sediment pore waters and elutriates

Type	Test Species	Endpoint	Acute/ Chronic	Temperate/ Tropical	Reference
Bacterium	<i>Vibrio fischeri</i> (Microtox®)	15-min luminescence	Acute	Temperate	Environment Canada, 1992b
Microalga	<i>Nitzschia closterium</i>	72-h growth	Chronic	Temperate	Stauber et al., 1994
Microalga	<i>Nitzschia closterium</i>	72-h growth	Chronic	Tropical	Florence et al., 1994
Microalga	<i>Phaeodactylum tricornutum</i>	72-h growth	Chronic	Temperate	Franklin et al., 2001
Microalga	<i>Entomoneis cf. punctulata</i>	72-h growth	Chronic	Temperate	Adams and Stauber, 2004
Microalga	<i>Entomoneis cf. punctulata</i>	3- and 24-h esterase activity	Acute	Temperate	Adams and Stauber, 2004
Macroalga	<i>Hormosira banksii</i>	1-h fertilisation	Sub-chronic	Temperate	Gunthorpe et al., 1997
Macroalga	<i>Hormosira banksii</i>	48 and 72-h germination and cell division	Sub-chronic	Temperate	Kevekordes and Clayton, 1996
Scallop	<i>Mimachlamys asperimma</i>	48-h larval development	Sub-chronic	Temperate	Krassoi et al., 1996
Oyster	<i>Saccostrea</i> sp.	48-h larval development	Sub-chronic	Temperate	Krassoi, 1996
Sea urchin	<i>Heliocidaris tuberculata</i>	1-h fertilisation	Sub-chronic	Temperate	Simon and Laginestra, 1997
Sea urchin	<i>Heliocidaris tuberculata</i>	72-h larval development	Sub-chronic	Temperate	AWT ES&T, 1996
Polychaete worm	<i>Galleolaria caespitosa</i>	48-h larval development	Sub-chronic	Temperate	Ross and Bidwell, 2001

5.7 Data Analysis and Interpretation

The objective of data analysis is to quantify contaminant effects on replicate groups of exposed test organisms and to determine if these effects are significantly different from those occurring in the controls or reference sediments. Statistical endpoints such as percentage survival (mean \pm SD) or percentage healthy cells should be calculated for each treatment and compared to the reference sediment or control sediment data. After testing the data for normality and homogeneity of variance (USEPA, 1994), pairwise comparisons of treatment versus control (or reference) data are made e.g. by Student's *t* test. If the requirements for normality and homogeneity of variance are not met, the data can be transformed and retested or if the data still fail, a non-parametric test such as the Wilcoxon Rank Sum test can be used for the statistical comparison. Further details of a range of statistical methods for data analysis are provided elsewhere (USEPA, 1994).

As part of the quality assurance procedures, criteria for test acceptability in the controls must be examined, together with the reference toxicant data and sediment/water physicochemical parameters. If the test meets the appropriate criteria, data interpretation can then be carried out.

In order to interpret any toxicity detected, it is important to ensure that the tolerable range of the test organism to physicochemical characteristics of the test sediments, pore waters and overlying waters, such as DO, pH, salinity, particle size, ammonia and sulfide, are not exceeded.

Different criteria can be used to determine whether or not the test sediment is toxic. For amphipod acute tests, Environment Canada recommends the use of pass/fail criteria based on mortality being significantly different and exceeding that of the reference sediment by more than 20%. In the absence of a suitable reference sediment, the test sediment is judged to be toxic if mortality is more than 30% higher than the control and significantly different (Environment Canada, 1998). For the benthic algal test, a sediment is considered

toxic if there is more than a 20% inhibition in enzyme activity compared to the reference (or control) sediment (i.e. <80% of the control), and, is significantly different to the control sediment ($p \leq 0.05$) (Adams and Stauber, 2004).

Sediments may have 'natural' toxicity due to the presence of ammonia or hydrogen sulfide, decomposition products of organics in aerobic and anoxic sediments respectively. Ammonia was found to have a probability of up to 18% of being the only cause of toxicity in a series of 322 marine sediments in the eastern USA (Moore et al., 1997). The presence of ammonia may therefore confound interpretation of results and in particular have a profound effect on regulatory decisions regarding ocean disposal of dredged sediments. Inclusion of reference sediments is therefore critical in aiding the interpretation of the toxicity test results.

There are a number of other factors that affect test organism response aside from those related to sediment-associated contaminants. They include the effects of sediment heterogeneity, sediment manipulations, temperature, light, food availability (sediment nutrition) and organism mobility. These factors may result in significant toxicity (negative effects relative to control responses) when contamination is low, greater toxicity than expected, or no (or less) observed toxicity when contaminants are present at concentrations expected to cause great toxicity.

The heterogeneity of natural sediments often makes extrapolation from laboratory studies to the field difficult. As discussed in detail earlier (Section 3.4), all manipulations to sediments (collection, handling, and storage) will alter the bioavailability and concentration of contaminants by changing the physical, chemical, or biological characteristics of the sediment.

Differences in the temperature used for testing and those in the field (particular for tropical or polar samples) will affect contaminant solubility, partitioning, and other physical and chemical characteristics.

Photo-induced toxicity has been observed to be an important factor in controlling the toxicity of some contaminants associated with sediment (e.g. certain PAHs) (see Section 6.2.2). The light conditions used during tests may need to reflect lighting conditions at the field site (e.g. at a certain water depth or sun-exposure on a mud-flat).

Motile organisms might avoid exposure in the field, and may need consideration in the final assessment process. It is often recognised that organisms cannot reproduce in contaminated sediments, but they can reside in them (i.e. populated by recruitment).

5.8 Toxicity Identification Evaluation (TIE) for Whole Sediments

The identification of toxicants affecting aquatic ecosystems, in particular the health of benthic organisms, is becoming an increasingly important part of sediment quality assessment programs. TIE procedures involve the manipulation of sediments, or sediment components (e.g. pore waters) to remove or mask the effects of particular classes of contaminants (e.g. PAHs, metals), thus allowing identification of the class(es) responsible for the observed toxicity (Ankley and Schubauer-Berigan, 1995; Kosian et al., 1998; Burgess et al., 2000; Ho et al., 2002; NFESC, 2003; Burgess et al., 2003; Burgess et al., 2004; Ho et al., 2004). Most procedures involve manipulation of sediment pore waters (or elutriates) following isolation from whole sediments. Fewer studies have investigated whole-sediment TIE procedures (Ho et al., 2002). Although the development and testing of TIE procedures continues to be a priority for many groups involved in contaminated site assessment, the majority of the research is still focused on porewater TIE procedures (NFESC, 2003).

In the USEPA framework, TIE methods are divided into three phases: characterisation, identification, and confirmation (Ankley and Schubauer-Berigan, 1995; Burgess et al., 1996). TIE procedures for pore waters are generally cheaper, faster, and easier to conduct than the current 'developmental' whole-sediment TIEs (Carr and Nipper, 2003).

Current advantages of using porewater TIEs include:

- (i) the ability to test organisms that are not compatible with a solid matrix (i.e. sediment),
- (ii) pore waters are considered a major route of exposure of many toxicants,
- (iii) there is a good understanding of how sample manipulation affects sample chemistry.

However, there are a number of factors that disadvantage porewater TIE procedures, making it desirable to have whole-sediment TIE methods. Unfortunately these methods are insufficiently developed and more research is needed to make routine methods available. There is a recognised risk that porewater TIE procedures over-emphasise the importance of ammonia in sediment toxicity (Ho et al., 2002). Many of the sample manipulation artifacts that affect contaminant speciation and bioavailability (discussed in Section 3.4), also affect the results of TIE procedures.

Porewater TIEs have indicated that, among all sediments tested, there is no one predominant cause of toxicity; metals, organics, and ammonia play approximately equal roles in causing toxicity (Ho et al., 2002). Multiple toxicants are often identified as causing the observed toxicity, and among these toxicants, ammonia is a very prominent toxicant (particularly for marine sediments).

It is recognised that there are often inconsistencies between the results of bulk sediment and porewater toxicity tests (Carr and Nipper, 2003). The procedural differences between porewater and whole-sediment toxicity test methods (including sample preparation) make it desirable to have TIE procedures that can be applied to whole sediments. Whole-sediment TIEs are expected to be more 'accurate' and provide more realistic exposure pathways for organisms.

The addition of a metal-chelating resin to sediments had been found to be a useful whole-sediment TIE method that reduces the concentration and toxicity of metals (Burgess et al., 2000). The resin additions had only

minor effects on the toxicity of ammonia and a non-polar toxicant present in the sediments. Furthermore, the resin and accumulated metals were able to be isolated from the test system following exposures allowing for the initiation of the identification stage of the TIE procedure. While in the studies by Burgess et al. (2000), the sediments were artificially contaminated (spiked) with metals, the technique does show promise for further development. Removal of ammonia toxicity was achieved in whole-sediment toxicity tests by addition of the marine algae *Ulva lactuca*, or zeolite (Ho et al., 1999; Pelletier et al., 2001; Burgess et al., 2003, 2004). Powdered coconut charcoal addition has been found to effectively remove the toxicity of organic contaminants such as PAHs, PCBs and pesticides (Ho et al., 2004).

While whole-sediment TIEs may have advantages over porewater TIEs procedures in that they may better represent all the contaminant exposure pathways, there remain many challenges. Factors requiring further investigation include: the equilibration of sediments following TIE manipulations that affect contaminant bioavailability (Simpson and Batley, 2003), and whether the effects of the manipulation remain constant during the subsequent tests (i.e. 10-d acute or 40-d chronic toxicity tests).

The incorporation of knowledge of contaminant exposure pathways (pore waters, whole sediments) (Simpson and King, 2005), species-specific sensitivity to selected contaminants (Borgmann, 2000; King et al., 2006b) and the use of multiple species in experimental design (Isidori et al., 2003) is expected to improve future TIE methodologies.

Details of porewater and whole sediment TIE methodologies are not given in this Handbook, but a number of studies involving TIE development and application for pore waters (Ankley and Schubauer-Berigan, 1995; Kosian et al., 1999; Stronkhorst et al., 2003; NFESC, 2003) and whole-sediments (Burgess et al., 2000, 2003, 2004; Ho et al., 1997, 2002, 2004; Heinis et al., 2004) waters have been reported. Specialist toxicity testing laboratories that offer both a range of test

species and chemical analyses (manipulations) should be consulted for these studies. *In situ* toxicity identification evaluation (iTIE) methodologies are also being developed (Burton and Nordstrom, 2004a,b).

5.9 *In situ* Testing

Laboratory-based effects assessments may sometimes be poor measures of field-based exposures (Chappie and Burton, 2000; Burton et al., 2003; Burton et al., 2005). This is most likely to occur when exposure dynamics and interactions occurring at the field site cannot be correctly mimicked in the laboratory.

In situ tests may be defined as environmental measurements that are taken in the field, without removal of a sample to the laboratory to minimise manipulation. *In situ*-based effects measures may more accurately represent the effects occurring to single organisms or populations in the field. Advantages of *in situ* testing over laboratory-based tests include:

- (i) reduction of artefacts related to sediment sampling,
- (ii) better representation of both biotic and abiotic factors and stressors that affect contaminant exposure dynamics and uptake pathways,
- (iii) access to near-real time effects data,
- (iv) ability to assess temporal or episodic toxicity.

Disadvantages of *in situ* testing may include:

- (i) logistics associated with placement and retrieval of *in situ* chambers (deep sites) and integrity during placement (e.g. vandalism, high energy sites),
- (ii) organism stress if transported to the field site,
- (iii) rate of acclimation of organism to field conditions,
- (iv) artefacts associated with chamber burial and organism suffocation, mesh fouling due to suspended solids, low dissolved oxygen levels, food availability and predation,

- (v) changes to contaminant dynamics at the sediment-water interface due to chamber deployment,
- (vi) availability of reference sites that suitably represent the conditions at the test site,
- (vii) complexity of data interpretation.

The incorporation of results from *in-situ* tests in the WOE decision-making process is desirable. Currently there are no routine *in situ* tests involving field-based effects and exposure measures for assessing sediment toxicity. This field of ecotoxicology is growing and standardised techniques may become available in the future (ASTM, 2001; Chappie and Burton, 2000; Burton et al., 2003).

A recent workshop on 'In situ-based effects measures: linking responses to ecological consequences in aquatic ecosystems' was held

to critically evaluate the use of field-based effects and exposure measures using a variety of biological measures in the hazard and risk assessment process of aquatic ecosystems; thereby improving the accuracy and relevance of the decision-making process (Burton et al., 2005). Discussions focused on four main areas:

- (i) improving stressor-effect diagnostic capability in the assessment process,
- (ii) maximising efficiency, quality assurance and quality control, and broad-scale applicability of *in situ* field toxicity tests and experimental approaches,
- (iii) determining the ecological relevance and consequences of individual and food chain-based effect measures, and
- (iv) incorporating results from field-based effect methods into a weight-of-evidence decision-making process.

6.1 Bioaccumulation of Metals

The bioaccumulation of metals by invertebrates is complex and strongly affected by organism feeding behaviour (ingestion rates, selectivity of feeding) and the different sources of metals (overlying waters, pore waters, sediments and speciation) (Rainbow, 2002; Moore et al., 2005; Vijver et al., 2004; Simpson and King, 2005).

Biota-to-sediment accumulation factors (BSAFs) that are commonly used as indices for bioaccumulation for non-ionic organic chemicals were never intended for use with metals (Moore et al., 2005) and reviews of the literature generally indicate that BCF/BSAF data for metals show extreme variability and relationships between BCF/BSAF values and aqueous exposure are generally poor (or poor to reasonable when using log-log relationships) (McGeer et al., 2003). The use of BCF/BSAF as criteria for the hazard identification and classification of metals is inappropriate.

Body concentrations of metals (body residues) may provide useful information on possible effects only if strong and clear relationships exist between bioaccumulation and toxic effects (Borgmann, 2000; Borgmann et al., 2004; Simpson and King, 2005). For metals that are sequestered into non-toxic forms or are regulated over the concentration range of interest, the use of body concentrations to predict effects is not appropriate (Borgmann, 2000; Rainbow, 2002; Rainbow et al., 2004). Borgmann et al. (1991, 1998, 2001) found that chronic toxicity of Cd, Tl and Ni to the freshwater amphipod *Hyaella azteca* was a function of the total amount of metal accumulated, and not the total metal concentration in water or sediment. These relationships were used to calculate lethal body concentrations (LBCs) and internal effect concentrations (IECs). In contrast, copper is strongly regulated by *H. azteca* and no

relationship is found between body-copper and copper in water or sediments (Borgmann, 2000). Simpson and King (2005) have shown that, for the amphipod *Melita plumulosa* and the bivalve *Tellina deltoidalis*, LBCs of copper are poor predictors of toxicity. They showed that the toxic effect of copper in sediments will be determined by total copper concentrations, partitioning (K_d) relationships (sediment properties), organism physiology (uptake rates from waters, assimilation efficiencies from solids), and organism feeding behaviour (feeding selectivity).

The usefulness of metal bioaccumulation data for sediment quality assessment purposes has yet to be fully evaluated. Measurements of body concentrations of metals may be useful for predicting effects for non-essential and non-regulated metals. However, cause-effect relationships that exist during laboratory tests (when organisms are cultured and exposed to environmental samples) may not exist or may be more difficult to interpret for field-collected organisms where the exposure history is unknown (Borgmann, 2000). Toxicity is related to a threshold concentration of metabolically-available metal and not to total accumulated metal concentration (Rainbow, 2002; Vijver et al., 2004).

If metal bioaccumulation data are to be used in the sediment quality assessment, care should be taken to use a suitable depuration period (e.g. 24 h) for gut clearance before body concentrations of organisms are determined (Neumann et al., 1999).

It has been demonstrated that biomagnification of metals does not occur (Goodyear and McNeill, 1999), although secondary poisoning (trophic transfer of two trophic levels) may be observed, e.g. trophic transfer of Cd and Zn from bivalves to gastropods (Wang, 2002; Wang and Ke, 2002).

6.2 Bioaccumulation of Non-ionic (Hydrophobic) Organic Chemicals

Bioaccumulation refers to the accumulation of contaminants in the tissues of organisms through any route, including respiration, ingestion, or direct contact with contaminated sediment or water (USEPA, 2000a; Moore et al., 2005). Many non-ionic organic chemicals may also biomagnify (increase in concentration through three or more trophic levels) through food chains (Kelly et al., 2004). Most non-ionic (hydrophobic) organic chemicals, such as PCBs and PAHs, are readily taken up by many organisms and accumulate in animal tissues. Synthetic organic chemicals such as PCBs are highly resistant to metabolic degradation and so accumulate to high levels. While PAHs are readily taken up by many organisms, many are rapidly metabolised (Meador et al., 1995). Most of these degradation products, which may also be toxic, are not easily quantified by standard analytical methods. Bioavailability and organism physiology are the two most important variables affecting chemical contaminant body burdens (Landrum et al., 1996). Moore et al. (2005) review and discuss the many factors that affect the assessment of bioaccumulation.

Field measurements (body residues in field-collected organisms), laboratory measurements (bioaccumulation tests with laboratory animals), surrogate measures of bioaccumulation (biomimetic methods, gut fluid extraction) and modelling ((BSAF) and theoretical bioaccumulation potential (TBP)) can all be used for assessing bioaccumulation of organic chemicals. Each approach has a number advantages/disadvantages and assumptions/uncertainties associated with it (USEPA, 2000a; Moore et al., 2005).

6.2.1 Methods for assessing bioaccumulation of organic chemicals

Measuring bioaccumulation directly

Bioaccumulation (bioavailability) tests are designed to evaluate the potential of benthic organisms to bioaccumulate contaminants of concern from the sediment material (USEPA

2000a,b). Most bioaccumulation studies are conducted for 28 days, as this time is believed to be sufficient for many infaunal benthic species and for chemicals to reach at least 80% of steady-state tissue concentrations (Lee et al., 1993). Many species can metabolise organic contaminants (e.g. PAHs), and may give a misleading indication of bioaccumulation potential. Therefore, it is essential that bioaccumulation studies include one or more species with very low ability to metabolise organic contaminants. Species characteristics to consider when selecting organisms for bioaccumulation tests include most of the factors used to select toxicity test species (Section 5.2), but they need not be sensitive to contaminants. In addition to these criteria, the test species should (i) provide adequate biomass for analysis, (ii) ingest sediments, and (iii) be inefficient metabolisers of contaminants, particularly PAHs (USEPA 2000a,b). It is generally recommended that bioaccumulation tests include a deposit-feeding bivalve mollusc and a burrowing polychaete (Lee et al. 1993; USEPA 2000a).

To interpret bioaccumulation data, it is necessary to determine the tissue residue concentration that will cause adverse effects. The critical body residue (CBR) approach has been used as a model dose-response relationship in aquatic organisms (USACE/USEPA, 2002). The strengths of the CBR approach are that bioavailability, exposure to food, and accumulation/depuration rate kinetics are explicitly addressed. The major uncertainty of the CBR approach is determining a dose or response protective of ecological health. Uncertainties of using the CBR approach are discussed in Moore et al. (2005).

Estimation of theoretical bioaccumulation potential

BSAFs and theoretical bioaccumulation potential (TBP) are EqP-based screening tools that are useful for estimating the potential levels of bioaccumulation of persistent non-ionic organic chemicals by benthic organisms exposed to contaminated sediments (USEPA/USACE, 1998; USEPA, 2000a; Moore et al., 2005). For organics, BSAFs are typically

derived using a sediment concentration normalised to organic carbon and a tissue concentration normalised to its lipid content (Moore et al., 2004). TBP is the simplest and most easily understood model for estimating bioaccumulation, but as such, it is also subject to a large degree of uncertainty (USEPA/USACE, 1998; USEPA, 2000a). The bioaccumulation of non-ionic organic chemicals in marine organisms may differ due to many factors including, but not limited to, exposure medium, uptake rate, metabolic capability, lipid content, and feeding strategy (Meador et al., 1995; Moore et al., 2005). Two factors, lipid and organic carbon content, control, to a large extent, the partitioning behaviour of non-ionic organic chemicals in sediment, water, and tissue. The more hydrophobic a compound is, the greater the partitioning to these phases. These two factors, along with the octanol-water partition coefficient have been used to predict the partitioning and bioaccumulation behaviour of PAHs in sediments (Di Toro et al., 1991; Meylan et al., 1999; Di Toro et al., 2000; Di Toro and McGrath, 2000).

While EqP theory provides useful relationships between water concentrations and toxic effects to some benthic organisms, the approaches may under- or over-estimate bioaccumulation. The kinetics of processes that determine chemical bioavailability from sediments, or retention, metabolic degradation, or elimination from organisms, are not considered by the models. EqP approaches do not adequately consider sediment ingestion by marine invertebrates as a major exposure pathway (Meador et al., 1995; Kaag et al., 1997; Baumard et al., 1999). Particularly for deposit-feeding bivalves and worms, sediment ingestion is a major uptake route (Kaag et al., 1997; Mackay and Fraser, 2000; Weston and Maruya, 2002). The EqP approach does not generally take into account the different forms of organic carbon present in sediments, although approaches incorporating two forms have been developed (Gustafsson et al., 1997). Desorption kinetics of hydrophobic chemicals vary greatly depending on organic and sediment characteristics (Cornelissen et al., 1997;

Hendriks et al., 2001; Kraaij et al., 2003). For PAHs, first-order rate constants for the rapid and slow desorption of 10^{-1} - 10^{-2} h⁻¹ and 10^{-3} - 10^{-7} h⁻¹ have been observed respectively (Cornelissen et al., 1997). McGroddy et al. (1996) found only a fraction of 0.01-0.4 of sediment-associated PAHs appears to be involved in EqP with the pore water. Adsorption and desorption kinetics are not considered by EqP approaches for estimating bioaccumulation but these may greatly affect partitioning and bioaccumulation.

EqP approaches to estimating sediment-water partitioning of non-ionic organic chemicals are discussed in Section 4.3.3. For procedures for estimating bioaccumulation to organism tissues, consult recent publications (USEPA/USACE, 1998; USEPA, 2000a-d; Moore et al., 2005).

6.2.2 Photo-induced toxicity from bioaccumulated PAHs

Some PAHs exert a photo-induced toxicity after bioaccumulation in the tissues of invertebrates and exposure to ultraviolet radiation that greatly exceeds the effects of narcosis (Ankley et al., 1994, 1995; Swartz et al., 1997; Diamond et al., 2003). Recent experiments have also found that standard sediment toxicity tests conducted under normal lighting conditions (i.e. without a UV radiation source) are not sensitive to phototoxic effects (Swartz et al., 1997). The action of PAH phototoxicity is believed to be a result of the formation of superoxide radical anions. This reaction occurs in both external media such as water and within biological tissues. These reactive oxygen species can result in oxidative stress and subsequent cell death (Ankley et al., 1994; 1995). Not all PAHs are phototoxic. Quantitative structure-activity relationships (QSARs) have been found to be useful for identifying which PAHs should be phototoxic (Veith et al., 1995; Kosian et al., 1998; El-Alawi et al., 2002). Anthracene, fluoranthene, and pyrene are common PAHs well known for their photoinduced toxicity, whereas acenaphthalene, fluorene, and phenanthrene are commonly observed not to be phototoxic to benthic invertebrates (Ankley et al., 1995,

1997; Swartz et al., 1997). Exposure to UV radiation commonly increases toxicity 5- to 8-fold (Ankley et al., 1997; Boese et al., 2000).

The importance of photo-induced toxicity of sediment-associated PAHs will depend greatly on the organism (light-resistance of integument or carapace), organism behaviour (sediment burrowing depth), organism life stage (Pelletier et al., 2000), and light intensity and light penetration through the water column (turbidity) (McDonald and Chapman, 2002). In the clearest waters, 1% of the surface UV radiation can penetrate as much as 40 m, but penetration depths are

greatly decreased by DOC that strongly absorbs UV radiation. The ecological relevance of PAH phototoxicity remains uncertain and should not be a major part of the sediment quality assessment unless its ecological relevance is firmly established (McDonald and Chapman, 2002). Toxicity tests using epibenthic amphipod species may be used to determine effects due to photo-induced toxicity. While many amphipod species are largely protected from exposure to sunlight, they are surrogates for many benthic species living at the sediment-water interface.

7 ECOLOGICAL ASSESSMENT

7.1 *In situ* Benthic Community Assessment

This chapter provides a synthesis of a survey approach for investigating the potential effects of contaminated sediments on benthic assemblages. The approach is based on a correlative model that examines differences in benthic communities between impacted and reference locations, while identifying potential variables that may be contributing to these differences.

The aim is to assist users in designing, implementing, analysing and interpreting a survey program. A framework is provided that is sufficiently broad that it can be adapted to a variety of scenarios, with the users directed to appropriate references that may assist in more specific matters or alternative approaches. The framework focuses on examining differences in benthic assemblages between locations with enriched contaminant concentrations, and reference locations. Experimental designs for evaluating potential impacts that have yet to occur are not discussed, e.g. the ecological impact of a proposed galvanising plant. Alternate experimental designs (e.g. Beyond-BACI) for monitoring such responses are reviewed by Underwood (1991). To assist the users, examples from a recent study in Lake Macquarie, NSW, are presented. It is emphasised that the illustrated approach is one of many possible approaches; however, it discusses how to obtain data in a rigorous manner, is adaptable to a variety of statistical techniques, as well as being founded on sound principles of experimental design.

7.2 Benthic Community Assessment as an Ecotoxicological Assessment Tool

Benthic communities are a critical component of estuarine and marine ecosystems. They influence surface productivity, alter the

physical and chemical condition of the sediment and sediment-water interface, and transfer energy to higher trophic levels (Rowe, 1971; Gaston et al., 1998). Benthic communities are composed of fauna which exploit sediments in a myriad of ways (different potential exposure routes). They are relatively sedentary in comparison to other fauna (e.g. fish), can be quantitatively sampled, contain a range of life spans, and represent a variety of niches and life-cycles (White, 1988; Dauer, 1993; Warwick, 1993). In addition, communities manifest a range of direct and indirect responses to contaminants. Direct effects include changes in the composition and relative abundances of taxa due to differences in sensitivities among taxa and life cycles. Indirect effects may arise from changes in fecundity, alterations to food webs, and the cascading effects caused by the loss or increased prevalence of certain taxa (Antrill and Depledge, 1997; Fleeger et al., 2003). It is their ecological relevance and holistic response to environmental contaminants that makes benthic communities an important and viable tool for sediment quality assessment (Bilyard, 1987).

Single and multispecies laboratory toxicity tests are specifically designed to be transferable, accurate and precise. Although these tests can provide pertinent information regarding sediment toxicity at a specific time to specific taxa, extrapolating these findings for the protection of *in situ* communities is fraught with ambiguity. This is particularly relevant in Australia where there is a paucity of toxicological data for estuarine and marine taxa. By contrast, community-level field studies are location-specific, objective-specific, subject to a high degree of spatial and temporal variability, and generally confounded by additional intrinsic and extrinsic factors. Field studies are, however, inherently expensive and time-consuming, and thus a well-defined and systematic approach is essential. Failure to have such an approach

frequently results in irrelevant, highly ambiguous and incorrect findings, which subsequently provide management with poor or incorrect tools with which to make decisions. Nevertheless, field studies provide a critical link in sediment quality assessment, reflecting the collective response of a broad suite of taxa under ecologically-relevant and often dynamic conditions.

7.2.1 Asking the right questions

Prior to developing an experimental design, clear, relevant hypotheses need to be established. To do this, it is essential to establish why the study is being performed, to have an understanding of the system being monitored (e.g. type, source, concentrations and dispersal of contaminants; hydrodynamics; geomorphology), and to know the ecology of

the system from which the findings are to be drawn. In so doing, comparisons between unsuitable reference locations can be avoided, while ensuring that the ecological and environmental information obtained is at a prescribed level of confidence, and relevant to the overall objectives of the study. Although the underlying question may be based on identifying if there are differences in benthic assemblages between a contaminated location and several reference locations, more specific hypotheses need also to be defined which can be used to test the overall objectives.

These will need to be testable under a statistical framework and contain an acceptable level of uncertainty (error). An example of the impetus and some specific hypotheses for a survey study in Lake Macquarie, NSW, is provided in Box 1.

Box 1. Impetus for the Study in Lake Macquarie, NSW

Several studies have shown a distinct north to south gradient in the concentrations of lead, cadmium and zinc within the sediments, pore waters and biota of the lake, with concentrations elevated in proximity to several point sources, most notably a lead/zinc smelter situated in the northern-most reach of the lake (Cockle Bay). Trace metals have been shown to bioaccumulate in benthic invertebrates and fish. Nevertheless, it had yet to be established whether elevated trace metal concentrations were sufficient to express an effect at a community level.

Prior to developing any specific hypotheses, a literature review of the lake was undertaken to gain an understanding of the potential sources and variety of contaminants, the benthic ecology of the system, and the hydrodynamic processes occurring within the system. This information was used to assist in developing appropriate hypotheses about how stress could be expressed, in finding suitable locations, identifying potential confounding factors (e.g. fluvial inputs and vastly different substrates), and in identifying the type, dispersal and concentrations of the putative contaminants.

Aim and objectives of the study

The overall aim of the study was to determine if there was a correlative relationship between benthic assemblages and trace metal concentrations along the trace metal gradient within Lake Macquarie, and if so, to determine where these differences were indicative of ecological stress.

Based on an extensive literature review, several null hypotheses were formulated. Examples included:

H₁: There is no significant difference in the mean total abundance; the abundances of selected taxa; and the community indices of diversity, richness and evenness among locations within Lake Macquarie.

H₂: There is no significant difference in the benthic assemblages among locations within Lake Macquarie.

Table 6. Statistical conditions and types of statistical errors formed from null hypotheses testing

	Reject null hypothesis	Accept null hypothesis
Impact consideration:	Correct Decision Impact detected	Type II Error Impact not detected
No impact consideration:	Type I Error Impact detected but none exists	Correct Decision No impact detected; none exists

7.3 Experimental Design and Sampling

The experimental design provides the framework for the study, establishing boundaries for trade-offs between the level of uncertainty and the costs and time committed to the project. By developing a well-designed study, the major variables that influence the level of uncertainty can be moderated, e.g. spatial and temporal variability, errors, and biases in statistical approaches.

Estuarine studies are often performed over large areas, contain a variety of different habitats, and experience dynamic tidal and seasonal patterns. Benthic assemblages and environmental variables can vary significantly across a range of spatial and temporal scales (Morrissey et al., 1992a,b; Morrissey et al., 1994a,b), and thus require an appropriate experimental design and sampling techniques to accommodate this variability. The appropriate selection of reference locations is a difficult task, but nonetheless, a critical one. In many studies, potentially-impacted locations are compared to either a single location or a series of unsuitable locations. For example, reference locations are used that are still influenced by the contaminants (i.e. are not independent), are historically-contaminated, or are subject to other disturbances such as stormwater inputs, eutrophication, or large fluctuations in tidal salinity regime. Consequently, the findings of such studies may indicate that there is no difference between the contaminated location and the 'reference' location(s), resulting in the conclusion that the contaminants pose no significant ecological threat. This interpretation would be obviously confounded and possibly erroneous.

The null hypothesis (H_0) of an experiment is generally, but not limited to, a hypothesis of no relationship (or difference) between

population parameters (Quinn and Keogh, 2002), e.g. the population means of an unimpacted and impacted location. Statistical testing of the null hypothesis can produce four outcomes: the correct acceptance or rejection of the null hypothesis, or the incorrect acceptance or rejection of the null hypothesis (Table 6). When H_0 is erroneously rejected, i.e. a significant difference was detected when there was not one, the error is referred to as a Type I error.

In cases where H_0 was accepted, when in fact a significant difference did occur, the error is a Type II error. Obviously, it is optimal to keep both errors as small as possible; however, practical limitations such as resources require a compromise. Simply reducing the likelihood of a Type I error by increasing the alpha (α) value (the value which determines at what level the p -value (p) will be considered significant) will increase the likelihood of a Type II error. Generally, α is set at a specific conventional level, e.g. $\alpha = 0.05$, that is, when $p \leq 0.05$, the null hypothesis is rejected.

From a risk assessment perspective, it is the Type II error which requires careful consideration, as this may create the erroneous assumption that no impact has occurred, and therefore no remedial action is required (Quinn and Keogh, 2002). Type II errors are influenced by variability, and hence are study specific. A reduction of this error is achieved through the implementation of an appropriate experimental design, and sufficient statistical power to detect an effect (impact). Statistical power is a complex subject, and the appropriate number of samples required to detect impacts of a particular effect size should not be prescribed here as it related to the magnitude of the effect that is occurring. Readers are referred to Quinn and Keough (2002) and to Mapstone

(1995) when planning studies to minimise erroneous conclusions.

In survey studies, true controls are unattainable, i.e. locations that are identical to the impacted location with the exception of the putative contaminants. A more realistic notion is to accept that the system is a modified one, and choose multiple reference locations that will minimise the influence of confounding factors such as large differences in sediment particle size (grain-size), nutrients, salinity, physico-chemistry, hydrodynamic processes, depth, etc. If comparisons are made between only two locations, e.g. near a smelter (contaminant source) and 10 km away in an adjacent bay (reference site), then any differences may not be linked to the smelter, and the assemblages may just be different. The ability for natural disturbances to obscure anthropogenically-induced changes in benthic assemblages is common in estuarine studies (e.g. Wu, 1982; Nipper et al., 1998; Saiz-Salinas and Gonzalez-Oreja, 2000; Mistri et al., 2001; Morrissey et al., 2003). In a comprehensive assessment of North Carolina (USA) estuaries, Hyland et al. (2000) found that 27% of the region studied contained impaired benthic assemblages while no significant concentrations of contaminants were identified, suggesting the influence of natural disturbances and/or unmeasured contaminants. These findings emphasise the need for multiple reference locations, and the difficulty in making assumptions about observed differences between contaminated and reference locations. The following references provide a better understanding of experimental design: Cochran and Cox (1957), Underwood (1994), Underwood (2000), and Quinn and Keough (2002).

The underlying objective of a sampling program is to collect sufficient samples at temporal and spatial scales appropriate for the hypotheses being tested, and to provide the tests with the desired statistical power. Although samples need to be randomly taken, pure random sampling of a location would require an enormous number of samples to obtain the relevant information, while producing a significant amount of data that would be redundant with regard to the

objectives of the study. As a means of increasing the probability of obtaining relevant information, and simultaneously reducing redundancy, assumptions regarding the distribution of the variables being measured must be made. In essence, the aim is to obtain representative samples from a defined component of the impacted location, and compare these two similar components to reference and other locations. For example, ranges for water depth, sediment particle size, salinity, physico-chemical properties of the water, algal mats and seagrass cover need to be established.

Nested (or hierarchical) designs incorporate randomly-stratified sampling, and are founded on encapsulating the variability at a series of scales. In the case of the nested example illustrated in Figure 3, it is within the defined ranges discussed above that the sites are randomly selected, and subsequent random samples are obtained. Each location is divided into four sites from which four replicates are taken, with the entire sampling regime being repeated on two occasions (Times 1 and 2). Consequently, each location reflects the variation that occurred among the sites and within sites (4 replicates). Underwood (1997), and Quinn and Keough (2002) provide excellent reviews of nested designs and their corresponding statistical analyses. Nested designs are adaptable to a variety of benthic studies, including examining differences between impacted and reference locations, and gradient studies where changes in benthic communities are examined along a graduation in contaminants (e.g. Lake Macquarie). Furthermore, nested designs should be employed for both biotic and environmental datasets, encapsulating the variability in all measurements, and permitting the relationships between the two matrices to be compared on a variety of scales.

Temporal changes are also important and need to be treated appropriately. However, an experimental design which included both a spatial and temporal nested sampling design would be exceedingly expensive and time consuming. An alternative approach is to randomly select times across the duration of the study, i.e. time becomes a random factor

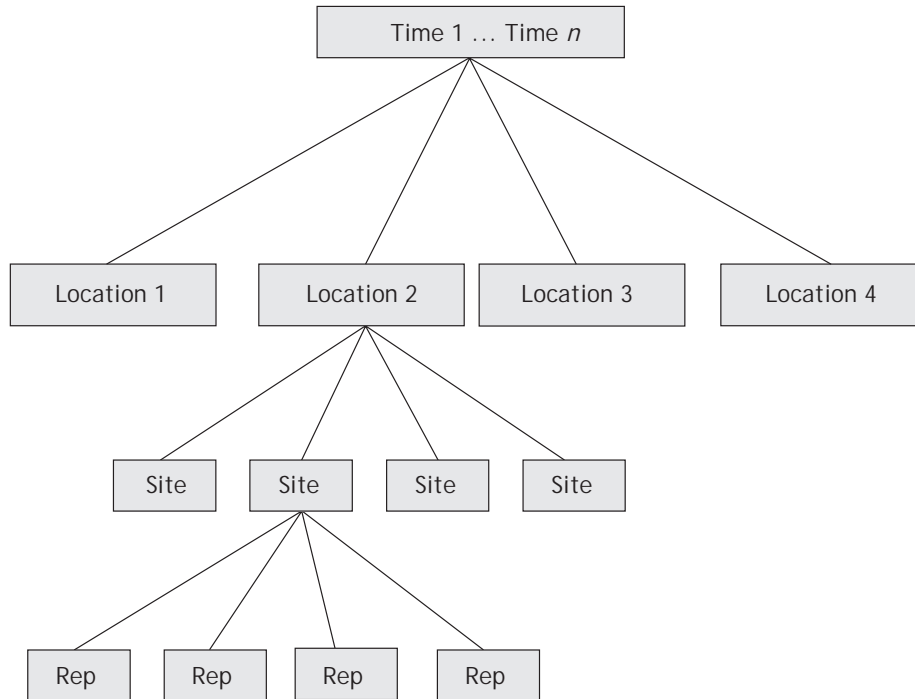

Figure 3. A nested design that was randomly replicated on n sampling occasions. Locations were fixed, with sites randomly nested within the locations and times.

as illustrated in Figure 3. In most incidences this would involve a stratified random approach. For example, if the study was only performed over a one-year period, randomly selecting the sampling dates across the seasons will provide a more representative sample of the variation than repeatedly sampling in one or two adjacent seasons. However, this does not show that there is a difference between seasons. In order for seasonal differences to be demonstrated, replication is required within and among seasons. For example, if the response of benthic communities was thought to be higher in summer than winter, then sampling should be randomly replicated within each summer and winter, and performed over multiple years.

7.4 Defining Benthic Communities, Taxonomic Resolution and Mesh Size

Macrobenthic infauna are defined as the invertebrate fauna which predominately live in or use the sediments. Estuarine waters can contain a wide and often dynamic range of

salinities, which can have a pronounced effect on the abundance and types of taxa. Consequently, boundaries for the types of fauna that should be included in analyses need to be established. In environments which maintain a salinity close to that of marine waters (31-33‰), freshwater fauna should be discarded from the data matrix, as they are not representative of the sampled assemblages; so too with pelagic taxa such as cladocerans and copepods. The larval forms of benthic taxa are also generally excluded from the matrix, as they are extremely difficult to identify, with changes in larval responses being aggregated into the overall attributes of the sampled communities. In systems with lower or more dynamic salinity ranges, location-specific boundaries for the taxa that should be sampled need to be considered. This will require a local knowledge of the benthos, which can be developed either through previous studies or a pilot survey.

In many contaminant studies, analyses at taxonomic levels coarser than the species level has resulted in a minimal loss of information,

Table 7. Commonly-used levels of resolution for common taxonomic groups

Taxonomic group	Taxonomic resolution for classification
Polychaete	Family
Mollusc	Family
Crustacea	Sub-order
Nemerta	Phylum
Sipuncula	Phylum

Box 2. Taxonomic Resolution used in Lake Macquarie (2000)

In 2000, 64 sediment cores were collected from four locations in Lake Macquarie where the salinity range was stable between 30 and 34‰. Fauna were retained on a 1 mm sieve, with approximately 5,600 individuals being collected representing the following groups of taxa:

- Polychaetes – 25 families
- Mollusca – 23 families
- Crustacea – 4 orders
- Nemerta – Phyla

often aiding discrimination by reducing the confounding effect of natural spatial changes in species (Warwick, 1988; Ferraro and Cole, 1990; Somerfield and Clarke, 1995). Identification and enumeration at family level or higher significantly reduces processing time and costs. Commonly used levels of resolution for a variety of taxa are presented in Table 7, with similar resolutions frequently being used in several NSW estuary studies (Box 2) (Stark, 1998; Roach et al., 2001; Lindegarh and Hoskins, 2001). Even at higher taxonomic levels, it is essential for staff to be properly trained in order to correctly identify taxa, with confirmation of the taxonomic groupings being validated by a professional benthic taxonomist. In some cases, resolution may need to be performed at a finer scale than that suggested, e.g. in cases where the status of a specific species is of concern, or where complementary toxicity tests are being performed using taxa endemic to the study location. In these cases, professional taxonomic assistance is essential.

In addition to taxonomic resolution, the minimum size of the fauna to be collected must also be established. This is defined by the mesh size used to retain the fauna prior to sorting, with three mesh sizes commonly used: 500 µm, 750 µm and 1 mm. In a majority of applications the 500 µm mesh may be the most suitable, potentially encapsulating a greater number of individuals and taxa than the coarser sieve sizes. However, it should be noted that decreasing the mesh size will increase processing time, and hence trade-offs between processing time, number of replicates and community representation need to be considered.

7.5 Collecting, Preservation and Sorting of Benthic Communities

7.5.1 Collection of samples

Benthic communities can be sampled using both corers and grab samplers, with the choice of device dependant upon the environment being sampled, field conditions and the methods used in other studies which may be being used for comparisons. For both methods, effort should be made to ensure that consistent volumes of sample and the same portion of the sediment column are sampled, i.e. each sample must contain the same volume of sediment and penetrate into the same sediment depth. Although standardisation methods (e.g. individuals/m²) can be employed to correct for differences in sample volumes, it is emphasised that such corrections have some fundamental limitations. For example, increasing the volume of sediment not only increases the number of individuals that are sampled, but also the likelihood of sampling rarer fauna, and thus influences the number of taxa sampled. Standardising sample volumes only corrects for differences in abundances and not for the number of taxa. In addition, benthos may not be evenly distributed throughout the sediment column, with significant differences occurring along the sediment's vertical and horizontal profiles. Consequently, a simple correction for volume may not encapsulate stratified differences in the abundance and composition of the benthos.

Hand corers are suitable for intertidal areas and wading waters, and can also be used by divers in sub-tidal regions. Piston and gravity corers can also be used in sub-tidal regions. As previously indicated, the depth of the cores obtained must be consistent. The number of individuals and taxa that will be obtained from a core is highly variable, and ultimately dependent upon the site being sampled. In many instances, a core diameter of 100 mm will provide samples that encapsulate a sufficient surface area, although this may not be the case in some depauperate environments. If the core diameter is too small, then the number of taxa sampled may be reduced, especially in the case of larger or rarer species. In silty or muddy sands, a core depth of approximately 100 mm is generally sufficient to obtain a representative sample. In all cases, it is preferable to perform a pilot study as a means of identifying the relationship between depth and assemblages, as well as identifying specific features of the site that may influence the depth of the cores, e.g. shell layers, and hard substratum. To assist in obtaining cores of a consistent depth, a plastic ring can be attached to the core to prevent the core being pushed too deep into the sediments (Figure 4). Alternatively, clear Perspex corers can be used, although these can be susceptible to shattering.

Grab samplers (e.g. van Veen and Eckman) can be used in sub-tidal environments. Depending on their size, a single grab can obtain between 0.02 to 0.5 m² sediment, penetrating the sediment to a depth of up to 15 cm (USEPA, 2000e). In most grab samplers the penetration depth is adjustable, increasing the precision of samples, especially under varying sedimentary conditions. Grab samplers enable a greater volume of sediment to be sampled, and consequently, may be preferable to cores in low abundance environments. However, many grab samplers are heavy, and therefore require an appropriate winching system. Furthermore, the volume and penetration depth may vary due to the penetration angle of the grab and differences among sediments.

To ensure that grabs are consistent and suitable for benthic sampling, the following criteria should be accounted for:

- (i) sediment has not extruded from the sampler,
- (ii) water is still present in the sampler (i.e. the grab remained closed during retrieval),
- (iii) sediment surface is relatively flat, and
- (iv) appropriate sediment penetration has occurred, 4-5 cm in medium-coarse sand,

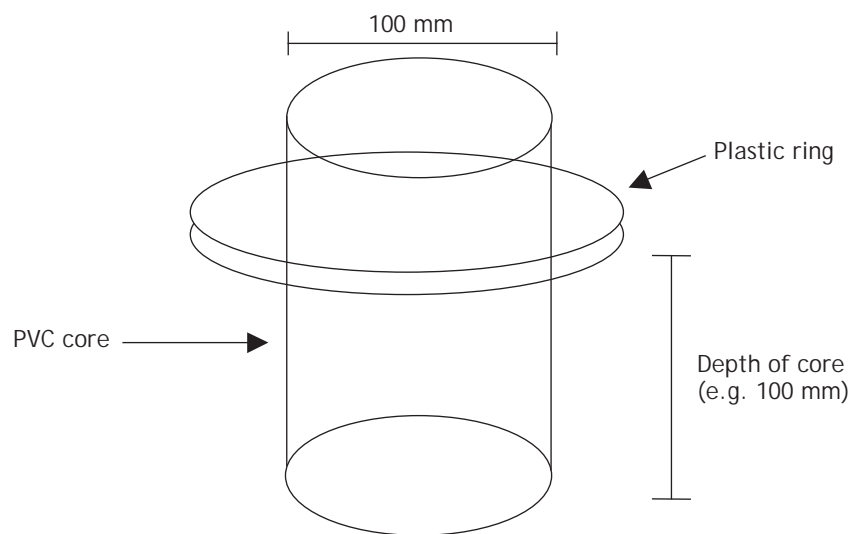

Figure 4. A 100 mm diameter PVC core with a plastic ring attached to ensure that the core depth (100 mm in the above example) is consistent

6-7 cm in fine sands, and >10 cm in silty sediments (Anon, 1987).

USEPA (2000e) provides an overview of grab samplers, including their suitability under various conditions, and the protocol for obtaining suitable samples.

7.5.2 Fixing and preserving macrobenthic invertebrates

Once collected, the sediment should be removed from the sampler prior to fixing. Samples containing the benthos should be placed on a plastic mesh sieve (0.5, 0.75 or 1 mm) and rinsed gently to avoid damaging the animals. Ideally, this should be done in the field, to reduce the amount of sample and to minimise damage to the organisms during transportation. The retained fauna are then carefully transferred into a labelled, airtight container, with the contents fixed using a 7% buffered formalin solution made-up in seawater. No more than half of the container should be filled by the sample, with the remainder of the container filled to the top with the fixative to minimise sloshing, and therefore damage, during transport. The containers should be carefully inverted several times to enable the fixative to penetrate the whole sample.

Concentrated formalin can be buffered by adding 28 g/L of borax (sodium borate), with the solution having a shelf life of approximately three months. Alternate buffers such as sodium bicarbonate (40 g/L) can also be used, although these may leave a precipitate on the fixed animals. The addition of a vital stain to the formalin solution (e.g. 4 g/L of Rose Bengal) will dramatically aid sorting, but some taxonomists have found the stain to hinder identification, although this is not generally a problem at a family level. The decision on whether to use stain or not should be discussed with the persons performing the identification prior to sampling. Waterproof tags with pen-written labels should be placed in each container as the formalin and alcohol (used for preserving) will remove labels written using 'permanent' markers. As formalin is a carcinogen, it is essential that it is poured in a well-ventilated

area, preferably in the field, with the handler using gloves. In the field, samples must be kept in a cool, dark environment.

After a minimum of two days, the formalin-preserved samples should be placed on a fine mesh (e.g. a stocking) and rinsed several times, in a fume hood, with a 70% ethanol solution (preservative) used to replace the formalin. As formalin's acidity increases with storage time, samples should be transferred to the ethanol solution within 10 d of collection. If the samples were not sieved in the field (i.e. the samples still contain sediment), compaction may occur within the containers, especially in the case of soft, fine sediments. As a result, the containers must be gently rotated every 48 h to ensure that the formalin has evenly penetrated the compacted sediment. Ethanol-preserved samples should be sorted underneath a dissecting microscope to ensure taxa that reside in sediment cases (i.e. unstained casings) are enumerated. Only whole individuals are counted. All animals should be preserved in ethanol with the exception of Orphiuroidea (e.g. brittle stars and basket stars), with these taxa requiring air-drying for identification (Anon, 1987). A guide to sorting is beyond the scope of this Handbook, although Birkett and McIntyre (1971) and Beesley et al. (2000) provide useful overviews for the novice.

7.5.3 QA/QC

QA/QC procedures for benthic macroinvertebrate sorting, identification and enumeration are as pertinent as those performed for chemical analyses, and consequently require development of and adherence to relevant protocols.

Where biomass is measured, balances must be calibrated on a weekly basis, whilst microscopes must be regularly serviced.

Staff will require initial training by taxonomic experts, and should have up to date taxonomic keys at their disposal. Staff should also participate in regional standardisation programs, if available (Anon, 1987). Confirmation of taxonomic identification should be performed both internally and

externally, with at least 5% of the samples re-identified by an additional qualified internal staff member, and at least three of each taxa being verified by an external benthic taxonomic specialist (Anon, 1987). Externally verified taxa (reference taxa) should be kept in the laboratory to enable comparisons to be made throughout the identification processes, and for future reference through the creation of a reference library. The reference collection's integrity must also be regularly monitored, with the samples being regularly topped-up with ethanol to prevent desiccation. Full-strength ethanol (95%) is preferable under these conditions due to its slower evaporation rate (Anon, 1987). Filling the mouth of the individual vials with cotton wool will reduce buoyancy within the container, and prevent the loss of the vial's contents.

All specimens (including composites) should be labeled appropriately, with the information interpretable to any potential users. Basic information should include the name of the taxa, date identified, survey, site, date collected, sorter's initials, and if the taxa has been externally validated. Each taxon from each sample should be placed in its own vial, and labeled appropriately. All vials for a given taxon should be subsequently stored in a single large jar containing 70% ethanol, and sealed to reduce evaporation.

Overseas studies have suggested that 20% of each sample should be resorted for QA/QC by an additional, internal specialist (Anon, 1987). This is done by obtaining a representative subsample (approx. 20% of the sample's volume) subsequent to being spread on a sorting tray, and prior to sorting. The aliquot is then carefully re-examined under a microscope, using 25 x magnification, to ensure that an adequate percentage of individuals was initially sorted and correctly identified. Removal of 95% or more of the individuals during the sorting processes is deemed acceptable. Violation of this should result in the resorting of the sample. The level of accuracy in taxa identification is generally determined by the facility, and is often dependent upon taxonomic resolution. In no cases should more than 5% of the taxa be incorrectly identified by the initial sorter. In all

cases where inconsistencies have occurred, all of the sorter's samples should be re-checked, and the identification problem clarified. This procedure, in concert with the internal and external confirmation procedures previously described, should result in very-low, if any, taxonomic errors.

7.6 Identifying and Measuring Ecological Stress

Community responses to contaminant-induced stress (or perturbation) are founded on ecological disturbance theories and general hypotheses associated with anthropogenic disturbances, and are therefore not contaminant specific. As a result, the appropriate environmental (abiotic) measurements must be collected simultaneously with the biotic measurements, enabling correlative patterns to be drawn between the two datasets. This must include natural variables (e.g. salinity, granulometry, dissolved oxygen) and contaminants. Due to the high costs and time associated with collecting and analysing chemical data, some prior knowledge of the potential contaminants, their concentrations and distributions through the sediments and waters is essential.

There are a number of approaches that are frequently used to assist in discriminating between stress and unstressed benthic communities, three of these are discussed: univariate measurements of communities, multivariate measurements, and graphical approaches. In addition, some approaches for linking benthic and environmental datasets are also presented.

7.6.1 Univariate measurements

Univariate measurements are frequently used to summarise the attributes of a community, and generally include the total number of individuals, indices for richness, diversity, and evenness, and the abundance of *a priori* selected taxa (Box 3). Generally these variables are relatively simple to calculate, and amenable to several commonly-used statistical techniques (e.g. ANOVA, correlation and regression analyses). In order to provide

Box 3. Univariate Measurements of the Biota used in the Analyses of Benthic Communities from Lake Macquarie

Univariate measurements were made of the biota sampled from four locations within Lake Macquarie in 2000 and 2003. There was an extensive decline in all measurements in Nord's Wharf (the location with the lowest concentrations of trace metals) in 2003. It was postulated that the decline in fauna within Nord's Wharf was the result of a natural phenomenon (e.g. unseasonal and prolonged rainfall).

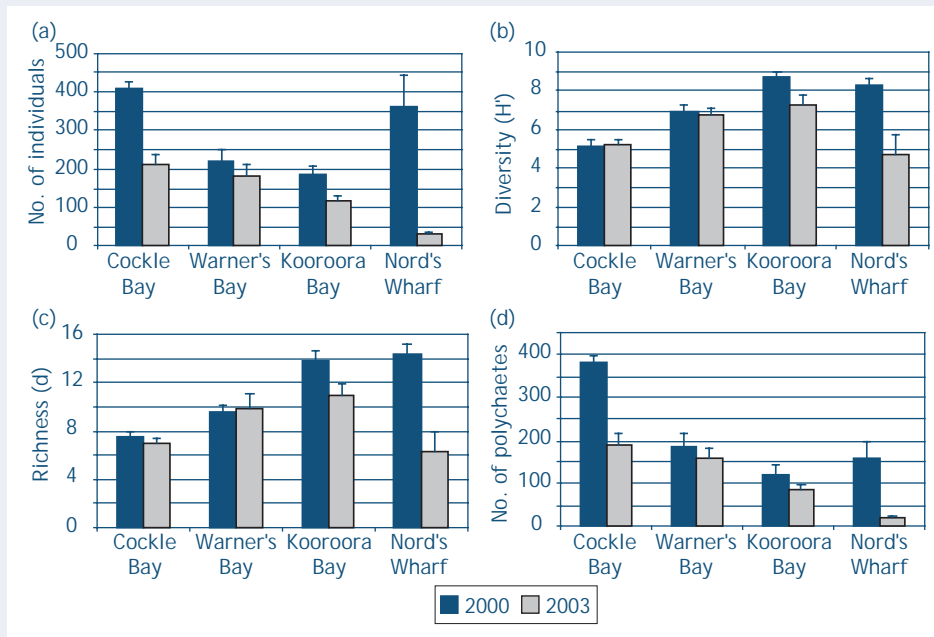

Figure 5. (a) No. of individuals, (b) Shannon-Weiner's index of diversity (H'), (c) taxa richness and (d) no. of polychaetes

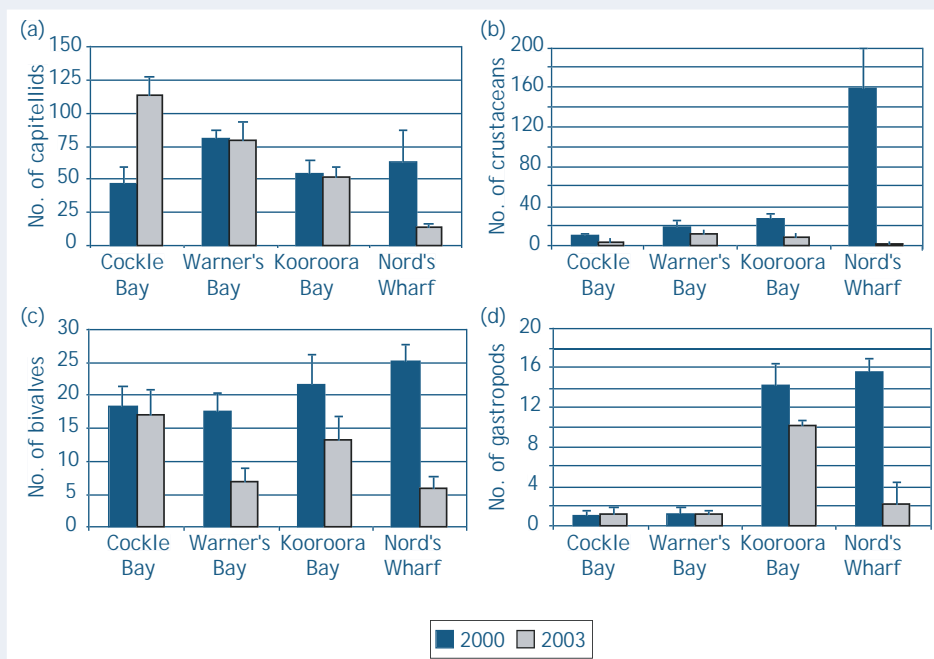

Figure 6. No. of (a) capitellid polychaetes, (b) crustaceans, (c) bivalves, and (d) gastropods

statistically-robust interpretations, metrics need to be able to show a high level of response to contamination, and possess a low level of natural variability, thereby reducing the uncertainty associated with a small number of samples.

In some studies, the abundance of specific taxa is used as an indicator of stress, with this response often considered to be bi-directional, e.g. an increase in opportunistic taxa such as the polychaetes Capitellidae, or a reduction of contaminant-sensitive taxa such as amphipods. It is emphasised that the selection of indicator taxa must be performed *a priori*, as *post-hoc* sifting through the data as a means of identifying patterns violates the concept of hypothesis testing, creating bias and often ecologically-irrelevant or confounded findings. Analyses based on the abundance of rare or spatially- and temporally-dynamic taxa should also be treated with caution, as the estimate of abundance will be strongly influenced by many factors, e.g. recruitment, seasonal variation and sampling design, increasing the level of uncertainty pertaining to the findings. Furthermore, in rare or patchily-distributed taxa, statistical analyses using standard parametric techniques may not be appropriate due to significant departures from the underlying assumptions of normality and homogeneity of variances.

A number of community indices are frequently used in benthic studies, e.g. measurements of diversity, richness and evenness. However, such indices must be used with caution, and appropriately. As in the case of other sampled variables, these indices are influenced by the sampling method, habitat (sediment type, geomorphology, vegetation, etc.), sample size, sampling depth, duration of sampling, time of year, and taxonomic level (Hughes, 1978; Washington, 1984). As a result, community indices values can only be compared to locations sampled within the same study, and under similar natural environmental conditions. In addition, sampled communities may have similar measurements (e.g. diversity scores), yet stark differences in taxa may occur among the communities. In isolation, no single community index (e.g. diversity) can be used to deduce a toxicological response at a

community level, although, the information produced from a number of indices may provide pertinent information on how community structure may be being modified by any contaminants.

Although commonly used, there is much criticism of univariate measurements because of the loss of information that occurs when assemblages are reduced to a series of variables (Matthews et al., 1996). However, if founded on ecological information and theory, univariate analyses can provide additional, relevant information that may add weight in discriminating between impacted and reference locations. A comprehensive review of the various metrics is beyond the scope of this section. However, pertinent papers on the topic include those by Washington (1984), Rapport et al. (1985), Schindler (1987), Gray (1989), Keough and Quinn (1991) and Warwick (1993).

7.6.2 Multivariate measurements

In recent years there has been a substantial increase in the use of multivariate techniques in benthic contaminant studies. This has been primarily driven by an increase in the processing power of personal computers, increased access to statistical packages founded on analysing and interpreting benthic community data (e.g. Primer 5, 2001), and the general acceptance of these techniques by the scientific community.

In contrast to univariate approaches, multivariate techniques do not require the data to be reduced to a single variable, but rather comparisons are made between two or more sites by quantifying the similarities (and differences) in their taxa and their relative abundances. As a result, multivariate approaches can capture and reflect differences in whole assemblages. There are numerous multivariate approaches that can be used in the analysis and interpretation of benthic assemblages (Legendre and Legendre, 1998).

Non-metric multidimensional scaling (nMDS) is one of the most commonly-used ordination techniques as it is conceptually simple to understand, and is provided in the Primer

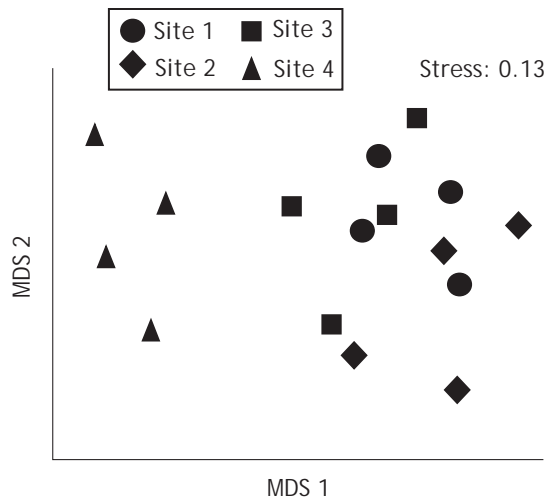

Figure 7. A two-dimensional ordination map showing the relationship between replicates (n=4) collected from four sites (stress = 0.13)

statistical package (Primer 5, 2001). In nMDS, the output is presented as either a 2- or 3-dimensional ordination 'map' in which samples that are more similar to each other are positioned closer than those that are less similar. In the example provided (Figure 7), it can be inferred that the 4 samples from Site 4 are more similar to each other than they are to the samples from the other sites. Although the Site 1 samples are relatively close together, it is difficult to establish if the samples from this site are different to those from Sites 2 and 3, due to some overlap in the replicates on both the x and y axes. Hence, nMDS does not test for difference between samples, but rather provides a graphical representation of the data that can be useful in gaining an understanding of how samples relate to each other, vary over time, or respond to environmental variables.

Although the graphical representation provided by nMDS is intuitive, the complex number of multivariate relationships that occurs in a large dataset, and the reduction of this information down to a 2- or 3-dimensional ordination map, can distort the spatial relationships between samples on the ordination map. Consequently, both increasing the size of the datasets and reducing the dimensions of the ordination will increase the

level of distortion. In most statistical packages, the level of distortion is calculated as a measure of 'stress', with a lower stress value indicating a more accurate representation of the spatial relationships on the ordination map, thereby increasing the power of the interpretation. In Figure 7, a stress measurement of 0.13 indicates that the ordination map provides an acceptable representation of the spatial relationships between the samples. As a guide, a more conservative interpretation should be taken in interpreting 2-dimensional ordination maps with a stress value above 0.2, with a stress value exceeding 0.3 providing an arbitrary spatial relationship between the samples (Clarke and Warwick, 1994).

Ordination techniques, including nMDS, do not quantify the variance among or within the samples as traditionally measured by ANOVAs. Consequently, additional analysis is required to establish if pre-defined groups or treatments (i.e. location, site or time) contain significantly different assemblages. The most commonly-used approach in benthic studies is Analysis of Similarities (ANOSIM), a function of the Primer software package (Primer 5, 2001). ANOSIM can employ the same design layouts commonly used in 1- and 2-way ANOVAs, including nested designs. The procedure is based on using a permutation test to compute a test static (R) and a randomisation approach to generate levels of significance. Subsequent to identifying if there are significant differences between treatments, pair-wise analyses can be performed to identify where differences between treatments occurred.

The recommended alternative to ANOSIM is Permutational Multivariate Analysis of Variance (PERMANOVA formally known as NPMANOVA), an intuitive freeware program available from www.stat.auckland.ac.nz/~mja/Programs.htm. PERMANOVA enables the user to choose any measure of dissimilarity (e.g. Bray-Curtis distance, Canberra distance and Manhattan distance), and can partition variability directly among individual terms using ANOVA models: single-factor, 2-factor, 2-factor nested ANOVA. The other advantage of this technique is in its simplicity, and the production of an output

that is similar to an ANOVA table, aiding the ability for this technique to be interpreted by those not formally familiar with the analysis.

Although the pair-wise comparisons test employed in ANOSIM and PERMANOVA may appear to be analogous to univariate multiple comparisons of means tests, such as Tukey and Student-Newman-Keuls, there is one distinct difference which must be considered. In the univariate tests, the effect of performing multiple tests (pair-wise Type I error rates), i.e. the accumulation of errors occurring from each test, is corrected to varying degrees within the test's algorithm, but this is not possible under the constraints of permutations tests. Consequently, either an increase in sample replication, or a less pragmatic view of significance is required when interpreting the results from pair-wise comparisons produced by ANOSIM and PERMANOVA. Although correctional tests are available that can be used to adjust the *p*-value in significance tests (e.g. Bonferroni's Test), they can produce very conservative levels of significance.

7.6.3 Graphical techniques

Graphical techniques complement rather than replace the more formal statistical analyses (univariate and multivariate). Many of the techniques are founded on ecological principles and provide outputs that can assist in both the interpretation and presentation of the findings. As with all techniques, there is a myriad of approaches, with the optimum approach being determined by the aims and hypotheses of the study.

K-dominance curves plot the cumulative ranked abundance against taxa rank (or log taxa rank), providing useful information about dominance, and the number of species (or taxa) that are dominating a community. *K*-dominance curves are often modified to create Lorenz curves, in which the taxa rank (x-axis) is rescaled and is measured against the cumulative abundance, enabling dominance to be partitioned from the number of taxa. The underpinning assumption for these curves is that 'stressed' communities will contain few taxa that will contribute to a significant proportion of the overall abundance, i.e. a reduction in evenness due to the dominance of

a few taxa. Consequently, the curves for the less even communities will sit above those that are more even. An example and explanation from Lake Macquarie is provided in Box 4 (Figure 8).

Another advantage of *K*-dominance curves is that they provide a template for another graphical technique, Abundance-Biomass Curves (ABC), in which biomass is superimposed with the dominance curve. The assumption of this technique is that, in a stable uncontaminated location, biomass will be higher than abundance due to a relatively high proportion of large, long-lived taxa (*k*-selected) such as bivalves. Conversely, it is proposed that in a grossly-contaminated location, the biomass will decline due to the loss of the *k*-selected taxa, with abundance remaining higher than biomass due to the relatively higher representation of a few small, short-lived taxa (*r*-selected). A hypothetical example of ABCs for both an uncontaminated and a severely polluted location is provided in Figure 9. As illustrated in Figure 9a (unpolluted) the biomass curve is above the cumulative abundance curve for log-transformed ranked taxa. In Figure 9b (polluted), the opposite occurs, with the abundance curve being above the biomass curve. In moderately-contaminated locations, a crossing of the two curves can be expected.

Although ABCs may assist in distinguishing broad response patterns between reference and polluted locations, a majority of the studies using this approach have been performed in systems contaminated by organic contaminants and nutrients, providing a lack of precedence for extrapolating this technique to aquatic systems specifically enriched with trace metals. Even in systems subjected to eutrophication, the response of fauna is not always consistent with the underlying assumptions of this technique (e.g. Lardicci and Rossi, 1998). An additional disadvantage of the technique is that samples need to be dried to obtain an accurate formalin-fixed dry weight, and in the case of calcareous taxa, e.g. molluscs and echinoderms, acidification of the calcium carbonate is also required. Consequently, the samples will not be available for re-examination if required.

Box 4. K-dominance Curves from Four Locations within Lake Macquarie

Cockle Bay has the highest concentrations of trace metals, followed by Warner's Bay, Kooroora Bay and Nord's Wharf.

The K-dominance curve for Cockle Bay was more elevated than the curves for the other locations, illustrating a heavy dominance of a small number of taxa, with the highest ranked taxa (spionids) contributing to over 65% of the average abundance for this location. In Warner's Bay and Nord's Wharf the dominance of a small number of taxa is less evident, however, the elevated curve in Warner's Bay suggests a less even assemblage than Nord's Wharf. The K-dominance curve for Kooroora Bay illustrates a more diverse and even assemblage in comparison to the other three locations.

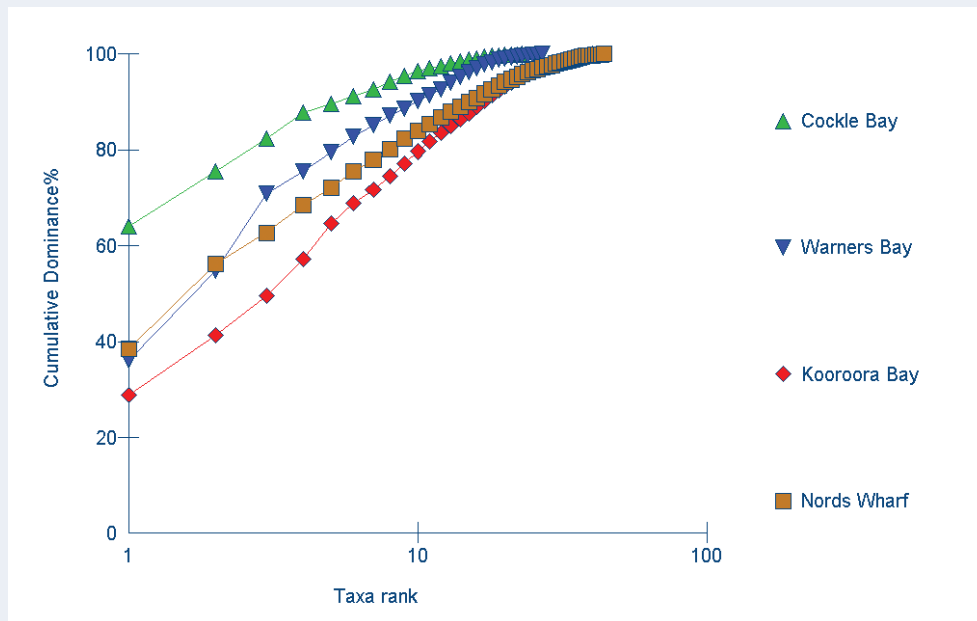

Figure 8. K-dominance curves for Lake Macquarie sites

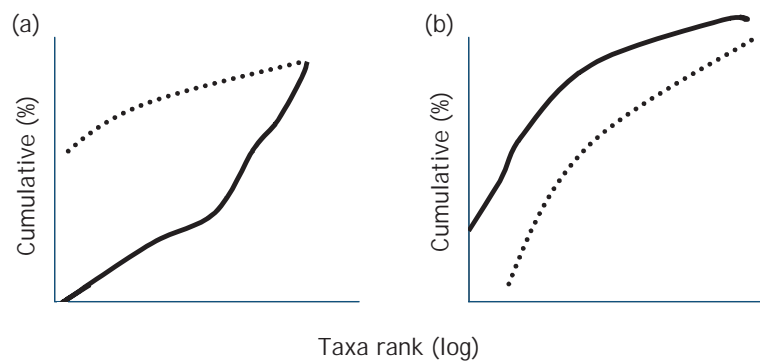

Figure 9. Abundance biomass curves (ABC) for uncontaminated and contaminated locations: (a) illustrates a hypothetical ABC for an unpolluted location as indicated by the elevated biomass curve (dotted line) above the abundance curve (solid line), (b) illustrates a hypothetical contaminated location as the abundance curve (solid line) is above the biomass curve (dotted line)

Box 5. nMDS Ordination Map of Benthic Assemblages Collected in Lake Macquarie

Green bubbles represent cadmium concentrations. Sites labelled CB were in close proximity to smelter, whilst sites labelled NW were furthest away.

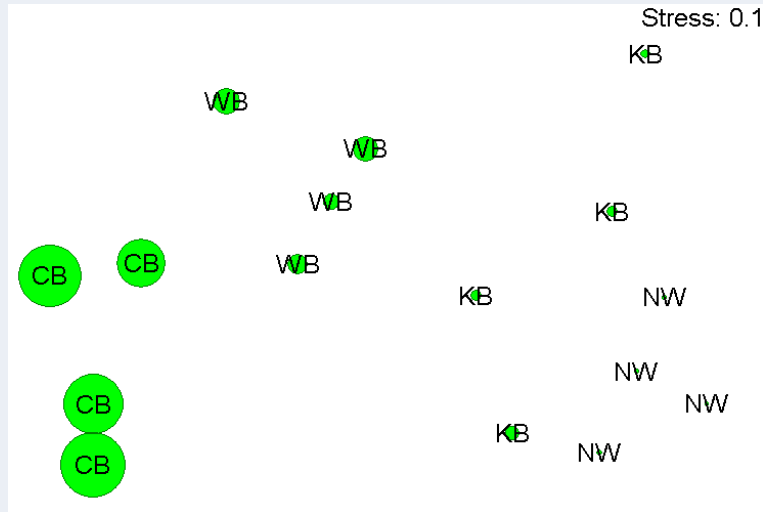

Figure 10. NMDS ordination map

Box 6. The Ten Best Combinations of Variables Produced from the BIOENV Analysis from a Survey Study in Lake Macquarie (2000)

K	Best combination of variable(s)
1	Cd (0.74)
2	Cd, Zn (0.73) Cd, Pb (0.70)
3	Cd, Pb, Zn (0.66) Cd, Pb, Mn (0.62) Cd, Pb, Fe (0.62) Cd, Pb, <63µm (0.61)
4	Cd, Pb, Zn, Mn (0.61) Cd, Pb, Zn, <63µm (0.61) Cd, Pb, Zn, Fe (0.60)

7.6.4 Linking benthic communities to environmental variables

The primary objective of survey studies is to examine relationships between benthic assemblages and concentrations of contaminants. As previously emphasised, this approach does not prove causality, but rather assists in identifying contaminants and other variables which correlate with changes in benthic assemblages. Three approaches are described, one is graphical, one based on correlations between benthic similarity matrices and environmental variables (unconstrained ordination), and the other is a constrained ordination technique.

A simple and often effective way of illustrating relationships between environmental variables and benthic assemblages is by overlying nMDS ordination maps with measurements of suspected correlating environmental variables. As illustrated in the Box 5 (Figure 10), the green bubbles representing cadmium concentrations are a similar size in the aggregated groups. For example, all CB (Cockle Bay) sites are grouped together and contain similar concentrations of cadmium, while all the NW (Nord's Wharf) sites are also grouped together, and contain similar, comparatively low concentrations of cadmium. However, it is noted that bubble plot overlays using ordination maps with high stress values may result in uncertain patterns.

A more formal approach for examining the correlative relationship between abiotic and biotic matrices is Primer's BIOENV (Primer 5, 2001). BIOENV performs series rank correlations between the biotic and abiotic datasets, producing a list of the best correlations. This approach is advantageous in that it not only identifies the best correlate, but also the best combination of correlates. Prior to performing the BIOENV procedure, it is critical that highly-correlated ($r = 0.95$) variables are removed as these will affect the procedure. In trace metal contaminant studies, there are generally several metals that are highly correlated as they are often derived from the same source, e.g. factory or smelter. The production of draftsmen plots and the

output from Pearson correlation coefficients can be used to identify highly correlated variables, and variables that may require transformations. Box 6 shows the results from a BIOENV procedure produced on the same data illustrated in Box 5. The results show that cadmium ($r = 0.74$) was strongly correlated (including combinations of variables used) with changes in benthic assemblages, with a combination of cadmium and zinc ($r = 0.73$) producing a similar result. In addition, the results show a stronger relationship between benthic assemblages and trace metal concentrations than they do with sediment particle size.

The methods previously described relate the results of an ordination of biological data (e.g. relative differences among samples as seen in an ordination plot) to particular environmental variables, either through a graphical approach such as the bubble plots or a statistical approach such as BIOENV. In both approaches, the environmental data are not taken into account for the ordination of the biological data. This is called an unconstrained or indirect analysis. An alternative approach, is to use constrained or direct analyses which allow the environmental data to be integrated directly into the analysis, allowing the partitioning of the total variance of the biological data into components of variation such as space, depth, time, contaminant concentrations and variation among replicates. This is sometimes preferred when we have some *a priori* notion of what may be useful in helping draw the ordination, e.g. where a clear contamination gradient is present at a location and we might expect the benthic communities to change with respect to the concentration of the contaminant.

Depending on the type of data being analysed there are two main statistical approaches:

- (i) Weighted summation, where the model assumes a linear response and the data represent absolute differences. For example, contaminant concentrations in fish are typical of these data. The main type of constrained analysis used for these data is redundancy analysis (RDA).

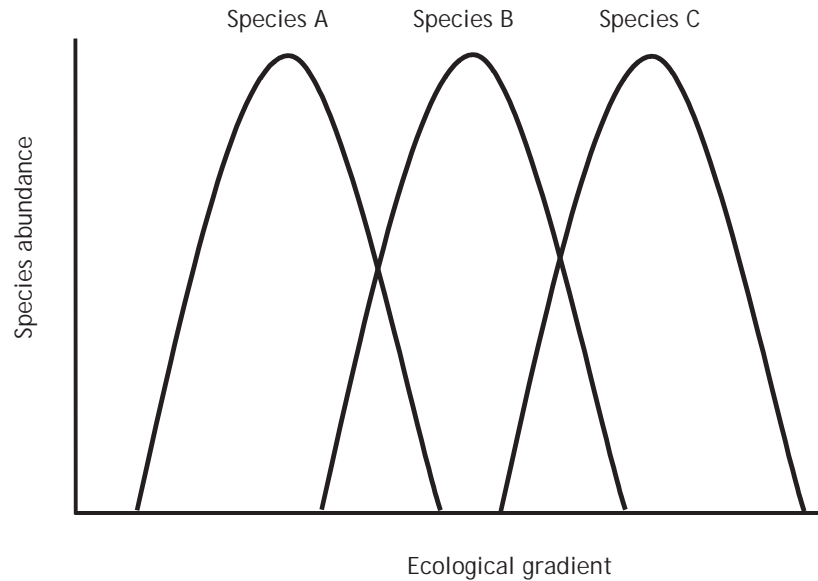

Figure 11. An example of unimodal responses in the abundance of species A, B and C

- (ii) Weighted averaging, where the model assumes a unimodal response and the data represent compositional differences (Ter Braak, 1995). Biological community data (e.g. species \times space) are typical of these data types (Figure 11). The main analyses used for these data are either Canonical Correspondence Analysis (CCA) or Detrended Canonical Correspondence Analysis (DCCA). The main advantage of this approach is that it may provide clearer patterns in benthic communities with respect to particular variables, and also provide circumstances to determine threshold levels at which contaminants may be causing effects.

The main package used for these analyses is CANOCO (2002), but there are other packages such as PC-ORD (1999), which do many of these analyses. These methods have been described in detail in the literature (Ter Braak, 1995; Legendre and Legendre, 1998), and there are examples where these techniques have been applied to investigations of relationships between contamination and benthic communities (Rascinski et al., 1997; Guerra-Garcia et al., 2003; Morrisey et al., 2003), and others which have examined relationships between benthic communities

and non contaminant variables (Ysebaert and Herman, 2002).

7.7 Placing Benthic Community Studies in Context

Assessment of *in situ* benthic communities provides important information on the level of biological organisation and over a temporal scale that cannot be maintained within the laboratory. However, field studies are not a surrogate for toxicity tests, as they are not based on the underlying experimental principles of cause and effect. Under the sediment quality assessment framework described in Section 1.3, multiple LOEs from a combination of chemical, biological and ecological studies are required to increase our capacity to assess the risk associated with contaminated sediments. If there is no observed effect on benthic communities utilising a suitable experimental design and analyses, then this would indicate that there is low risk of contaminant-induced perturbation. This does not negate that possibility that trace contaminants are affecting benthic communities, it only reduces the likelihood that these are having a significant impact under the frame of reference chosen to measure ecological stress. Consequently, how

stress is defined, measured and quantified will determine the ecological outcomes of the study.

In cases where a significant effect has been demonstrated, manipulative experiments such as TIE may be required to identify the casual agent (Section 5.8). If remedial actions are dictated by the sediments *per se* and not a specific contaminant, e.g. site remediation rather than monitoring a point source, then other approaches such as sediment translocation studies can be employed. In these studies, defaunated sediments from the contaminated and reference locations are translocated to several (spatially-replicated) independent, non-contaminated locations; with changes in benthic recolonisation used as measure of toxicity (this includes avoidance). The same univariate, multivariate and graphical techniques as described earlier in this section can be used in these studies. The disadvantage of this technique is that there are no true controls, and therefore no actual casual agents can be identified. The

approach simply indicates if the sediments as a whole influence the composition and abundance of recolonised benthos. Although some studies use spiking techniques to mimic the contaminant concentrations found within contaminated locations, and are thus able to create an experiment control, this technique is not advised for location-specific sediment quality assessments, as spiking may poorly replicate the biogeochemical status of the sediments or pore waters.

In this section, we have illustrated how univariate statistics, multivariate statistics and graphical techniques can be used to relate benthic assemblages to contaminant concentrations. In the illustrated example, the results of the Lake Macquarie study clearly show that elevated lead, cadmium and zinc concentrations are impacting on benthic communities. Taken together with toxicity studies and sediment translocation experiments, trace metals in sediments are affecting the ecology of sediments in Lake Macquarie.



8 CONCLUSIONS

The use of multiple LOEs, consistent with the integrated assessment philosophy of the ANZECC/ARMCANZ (2000a) guidelines, is currently the best approach to assessing sediment quality. This can be achieved by extending the current ANZECC/ARMCANZ decision framework to include bioaccumulation and ecological assessments, or by combining these and other LOEs (chemistry, toxicity) in a WOE framework. Thus, ideally, investigations should combine assessments of

- (i) sediment chemistry (e.g. exceedances of SQGs), including contaminant bioavailability tests (e.g. porewater measurements, acid-volatile sulfide (AVS), biomimetic approaches for hydrophobic organic contaminants),
- (ii) toxicity testing (e.g. multiple species, varying exposure pathways, acute and chronic endpoints such as mortality, growth, reproduction, avoidance).
- (iii) bioaccumulation/biomagnification, and
- (iv) benthic community structure (e.g. ecological malfunction).

Toxicity identification evaluation (TIE) and other causality considerations may also be of value. The combination and interaction between LOEs should be considered in applying these in a WOE framework (e.g. particle size affects contaminant bioavailability; bioavailability test results will affect the interpretation of toxicity and bioaccumulation data). WOE assessments often ultimately rely on best professional judgment, but the use of tabular decision matrices is the best approach for achieving transparency and comprehension by lay personnel. This Handbook describes approaches for measuring the different LOEs, but new LOEs are continuing to be developed and future sediment quality assessments may incorporate these. While a general approach is proposed, assessments frequently need to be custom-designed and LOEs chosen to suit the site-specific circumstances (e.g. site dynamics, sediment stability, groundwater flows, fluctuating overlying water conditions).

9 REFERENCES

- Adams, M.S., and Stauber, J.L. (2004). Development of a whole-sediment toxicity test using a benthic marine microalga. *Environ. Toxicol. Chem.*, 23, 1957-1968.
- Adams, M.S., Duda, S., Stauber, J.L., and Gunthorpe, L. (2001). Development of marine whole-sediment toxicity tests - NHT grant final report. National Heritage Trust Report, Environment Australia, Canberra, Australia, 200 pp.
- Ahrens, M.J., Hertz, J., Lamoureux, E.M., Lopez, G.R., McElroy, A.E., and Brownawell, B.J. (2001). The role of digestive surfactants in determining bioavailability of sediment bound hydrophobic organic contaminants to two deposit-feeding polychaetes. *Mar. Ecol. Progr. Ser.*, 212, 145-157.
- Allen, H.E., Fu, G., and Deng, B. (1993). Analysis of acid-volatile sulfide (AVS) and simultaneously extracted metals (SEM) for the estimation of potential toxicity in aquatic sediments. *Environ. Toxicol. Chem.*, 12, 1441-1453.
- Ankley, G.T., Collyard, S.A., Monson, P.D., and Kosian, P.A. (1994). Influence of ultraviolet light on the toxicity of sediments contaminated with polycyclic aromatic hydrocarbons. *Environ. Toxicol. Chem.*, 11, 1791-1796.
- Ankley, G.T., Di Toro, D.M., Hansen, D.J., and Berry, W.J. (1996). Technical basis and proposal for deriving sediment quality criteria for metals. *Environ. Toxicol. Chem.*, 15, 2056-2066.
- Ankley, G.T., Erickson, R.J., Phillips, G.L., Mattson, V.R., Kosian, P.A., Sheedy, B.R., and Cox, J.S. (1995). Effects of light intensity on the phototoxicity of fluoranthene to a benthic macroinvertebrate. *Environ. Sci. Technol.*, 29, 2828-2833.
- Ankley, G.T., Erickson, R.J., Sheedy, B.R., Kosian, P.A., Mattson, V.R., and Cox, J.S. (1997). Evaluation of models for predicting the phototoxic potency of polycyclic aromatic hydrocarbons. *Aquatic Toxicol.*, 37, 37-50.
- Ankley, G.T., and Schubauer-Berigan, M.K. (1995). Background and overview of current sediment toxicity identification evaluation procedures. *J. Equat. Ecosys. Health*, 4, 133-149.
- Anon (1987). Recommended protocols for sampling and analyzing subtidal benthic macroinvertebrate assemblages in Puget Sound. For the USEPA (Seattle, WA) and the Puget Sound Water Quality Authority (Olympia, WA). www.psat.wa.gov/Publications/protocols/protocol_pdfs/benthos.pdf
- Antrill M.J. and Depledge M.H. (1997). Community and population indicators of ecosystem health: targeting links between levels of biological organisation. *Aquat. Toxicol.*, 38, 183-197.
- ANZECC/ARMCANZ (2000a). Australian and New Zealand guidelines for fresh and marine water quality. Australian and New Zealand Environment and Conservation Council/ Agriculture and Resource Management Council of Australia and New Zealand, Canberra, ACT.
- ANZECC/ARMCANZ (2000b). Australian guidelines for water quality monitoring and reporting. National Water Quality Management Strategy Paper No 7, Australian and New Zealand Environment and Conservation Council / Agriculture and Resource Management Council of Australia and New Zealand, Canberra, ACT.
- APHA (1998). Standard methods for the examination of water and wastewater. American Public Health Association, American Water Works Association and Water Environment Federation (APHA-AWWA-WEF).
- ASTM (1992). Standard guide for conducting 10-day static sediment toxicity tests with marine and estuarine amphipods. Annual Book of ASTM Standards, American Society for Testing and Materials, Philadelphia, PA, USA
- ASTM (1998). Standard practice for oxidation-reduction potential of water, D 1498-00. American Society for Testing and Materials, West Conshohocken, PA, USA.
- ASTM (2000a). Standard guide for collection, storage, characterization, and manipulation of sediments for toxicological testing, E 1391-94. American Society for Testing and Materials, West Conshohocken, PA, USA.
- ASTM (2000b). Guide for core-sampling submerged, unconsolidated sediments, D 4823-95. American Society for Testing and Materials, West Conshohocken, PA, USA.
- ASTM (2001). Standard guide for conducting in-situ field bioassays with marine, estuarine, and freshwater bivalves, E 2122-01. American Society for Testing and Materials, West Conshohocken, PA, USA.
- ASTM (2003). Standard guide for designing biological tests with sediments, E 1367-03. American Society for Testing and Materials, West Conshohocken, PA, USA.
- AWT ES&T (1996). Toxicity testing of sewage effluent from coastal STPs in the Sydney and Illawarra regions. Australian Water Technologies Report prepared for Sydney Water, West Ryde. NSW, Australia.
- Azur Environmental (1998). Microtox acute toxicity solid phase test. Microtox® Manual, Azur Environmental, Carlsbad, California.
- Bailer, A.J., Hughes, M.R., Kyoungah, S., Noble, R., and Schaefer, R. (2002). A pooled response strategy for analyzing multiple responses to develop risk rankings in a weight of evidence evaluation of sediment contamination. *Human Ecol. Risk Assess.*, 8, 1597-1612.
- Batley, G.E. (2001). Assessing sediment quality, SETAC Globe, 2, 37-38.
- Batley, G.E., Burton, G.A., Chapman, P.M., and Forbes, V.E. (2002). Uncertainties in sediment quality weight-of-evidence (WOE) assessments. *Human Ecol. Risk Assess.*, 8, 1517-1547.

- Batley, G.E., Humphrey, C.L., Apte, S.C., and Stauber, J.L. (2003). A Guide to the application of the ANZECC/ARMCANZ water quality guidelines in the minerals industry, Australian Centre for Mining Environmental Research (ACMER), Brisbane.
- Batley G.E., Simpson, S.L., Stauber, J.L., King, C.K., Hyne, R.V., Gale, S.A., Maher, W.A., Chariton, A.A., and Roach, A.C. (2004). Procedures for measuring the risk posed by metal-contaminated sediment. NSW Environmental Trust Research Project No. 2000/RD/G0003 Final Report, CSIRO Energy Technology, Investigation Report No ET692, Lucas Heights, NSW.
- Batley, G.E., Stahl, R.G., Babut, M.P., Bott, T.L., Clark, J.R., Field, L.J., Ho, K., Mount, D.R., Swartz, R.C., and Tessier, A. (2005). The scientific underpinnings of sediment quality guidelines. In: Use of Sediment Quality Guidelines and Related Tools for the Assessment of Contaminated Sediments, Wenning, R., Batley, G., Ingersoll, C., and Moore, D., (editors). SETAC Press, Pensacola, FL, USA.
- Baumard, P., Budzinski, H., Garrigues, P., Narbonne, J.F., Burgeot, T., Michel, X., and Bellocq, J. (1999). Polycyclic aromatic hydrocarbon (PAH) burden of mussels (*Mytilus* sp.) in different marine environments in relation with sediment PAH contamination, and bioavailability. *Mar. Environ. Res.*, 47, 415-439.
- Beesley, P.L., Ross, G.J.B., and Glasby, C.J. (2000). Polychaetes and their allies: The southern synthesis: Fauna of Australia. Vol 4A Polychaeta, Myzostomida, Pogonophora, Echiura, Sipuncula. CSIRO Publishing, Melbourne, 465 p.
- Beesley, P.L., Ross, G.J.B., and Wells, A. (1998). Mollusca. The southern synthesis: Fauna of Australia. Vol 5, Part A xvi 563 pp. Part B viii, CSIRO Publishing, Melbourne, pp. 565-1234.
- Berry, W.J., Hansen, D.J., Mahony, J.D., Robson, D.L., Di Toro, D.M., Shipley, B.P., Rogers, B., Corbin, J.M., and Boothman, W.S. (1996). Predicting the toxicity of metal-spiked laboratory sediments using acid-volatile sulfide and interstitial water normalizations. *Environ. Toxicol. Chem.*, 15, 2067-2079.
- Besser, J.M., Brumbaugh, W.G., May, T.W., and Ingersoll, C.G. (2003). Effects of organic amendments on the toxicity and bioavailability of cadmium and copper in spiked formulated sediments. *Environ. Toxicol. Chem.*, 22, 805-815.
- Bilyard G.R. (1987). The value of benthic infauna in marine pollution monitoring studies. *Mar. Pollut. Bull.*, 18, 581-585.
- Birkett, L., and McIntyre, A.D. (1971). Treatment and sorting samples. In: *Methods for the Study of Marine Benthos*, IBP Handbook No. 16, Holme, N.A., and McIntyre, A.D., (editors). Blackwell Scientific Publications, Oxford, UK, pp. 156-168.
- Black, A.J. (2003). Environmental assessment in sea disposal of contaminated dredge spoils and excavated materials in temperate and tropical ecosystems of Western Australia. PhD Thesis, Curtin University of Technology, 156 pp.
- Black, A.J., Tsvetnenko, Y.B., and Evans, L.H. (2005). Direct toxicity assessment of contaminated sediments from Perth and Port Hedland using resident test species. (manuscript in preparation).
- Blaise C., and Ménard L. (1998). A micro-algal solid-phase test to assess the toxic potential of freshwater sediments. *Water Qual. Res. J. Can.*, 33, 133-155.
- Boese, B.L., Ozretich, R.J., Lamberson, J.O., Cole, F.A., Swartz, R.C., and Ferraro, S.P. (2000). Phototoxic evaluation of marine sediments collected from a PAH-contaminated site. *Arch. Environ. Contam. Toxicol.*, 38, 274-282.
- Borgmann, U. (2000). Methods for assessing the toxicological significance of metals in aquatic ecosystems: bioaccumulation-toxicity relationships, water concentrations and sediment spiking approaches. *Aquat. Ecosyst. Health Manag.*, 3, 277-289.
- Borgmann, U. (2003). Derivation of cause-effect based sediment quality guidelines. *Can. J. Fish. Aquat. Sci.*, 60, 352-360.
- Borgmann, U., Cheam, V., Norwood, W.P., and Lechner, J. (1998). The toxicity and bioaccumulation of thallium in *Hyalella azteca*, with comparison to other metals and prediction of environmental impact. *Environ. Pollut.*, 99, 105-114.
- Borgmann, U., Neron, R., and Norwood, W.P. (2001). Quantification of bioavailable nickel in sediments and toxic thresholds to *Hyalella azteca*. *Environ. Pollut.*, 111, 189-198.
- Borgmann, U., Norwood, W.P., and Babirad, I.M. (1991). Relationship between chronic toxicity and bioaccumulation of cadmium in *Hyalella azteca*. *Can. J. Fish. Aquat. Sci.*, 48, 1055-1060.
- Borgmann, U., Norwood, W.P., and Dixon, D.G. (2004). Re-evaluation of metal bioaccumulation and chronic toxicity in *Hyalella azteca* using saturation curves and the biotic ligand model. *Environ. Pollut.*, 131, 469-484.
- Brouwer, H., and Murphy, T.P. (1994). Diffusion method for the determination of acid-volatile sulfides (AVS) in sediment. *Environ. Toxicol. Chem.* 13, 273-1275.
- Bufflap, W.E., and Allen, H.E. (1995). Sediment porewater collection methods: A review. *Water Res.*, 29, 165-177.
- Bull, D.C., and Williams, E.K. (2002). Chemical changes in an estuarine sediment during laboratory manipulation. *Bull. Environ. Contam. Toxicol.*, 68, 852-861.
- Burdige, D.J., and Gardner, K.G. (1998). Molecular weight distribution of dissolved organic carbon in marine sediment pore waters. *Mar. Chem.*, 62, 45-64.
- Burgess, R. M. (2000). Characterizing and identifying toxicants in marine waters: a review of marine toxicity identification evaluations (TIEs). *Int. J. Environ. Pollut.*, 13, 2-33.
- Burgess, R.M., Cantwell, M.G., Pelletier, M.C., Ho, K.T., Serbst, J.R., Cook, H.F., and Kuhn, A. (2000). Development of a toxicity identification evaluation procedure for characterizing metal toxicity in marine sediments. *Environ. Toxicol. Chem.*, 19, 982-991.
- Burgess, R.M., Ho, K.T., Morrison, G.E., Chapman, G., and Denton, D.L. (1996). Marine toxicity identification evaluation (TIE) procedures manual: Phase I Guidance Document. U.S. Environmental Protection Agency Office of Research and Development Report EPA 600/R-96/054, Washington DC, USA
- Burgess, R.M., and McKinney, R.A. (1997). Effects of sediment homogenization on interstitial water PCB geochemistry. *Arch. Environ. Contam. Toxicol.*, 33, 125-129.

- Burgess, R.M., Pelletier, M.C., Ho, K.T., Serbst, J.R., Ryba, S.A., Kuhn, A., Perron, M.M., Raczewski, P., and Cantwell, M.G. (2003). Removal of ammonia toxicity in marine sediment TIEs: a comparison of *Ulva lactuca*, zeolite and aeration methods. *Mar. Pollut. Bull.*, 46, 607-618.
- Burgess, R.M., Perron, M.M., Cantwell, M.G., Ho, K.T., Serbst, J.R., and Pelletier, M.C. (2004). Use of zeolite for removing ammonia and ammonia-caused toxicity in marine toxicity identification evaluations. *Arch. Environ. Contam. Toxicol.*, 47, 440-447.
- Burton G.A., Rowland, C.D., Greenberg, M.S., Lavoie, D.R., Nordstrom, J.F., Eggert, L.M. (2003). A tiered, weight-of-evidence approach for evaluating aquatic ecosystems. In: *Sediment Quality Assessment and Management: Insight and Progress*, Munawar, M., (editor), *Ecovision World Monograph Series, Aquatic Ecosystem Health and Management Society Publ.*, Hamilton, Ontario, pp. 3-21.
- Burton, G.A., and Nordstrom, J.F. (2004a). An in situ toxicity identification evaluation method part I: laboratory validation. *Environ. Toxicol. Chem.*, 23, 2844-2850.
- Burton, G.A., and Nordstrom, J.F. (2004b). An in situ toxicity identification evaluation method part II: field Evaluation. *Environ. Toxicol. Chem.*, 23, 2851-2855.
- Burton, G.A., Batley, G.E., Chapman, P.M., Forbes, V.E., Schlekot, C.E., Smith, E.P., den Besten, P.J., Bailer, J., Reynoldson, T., Green, A.S., Dwyer, R.L., Berti, W.R., (2002). A weight-of-evidence framework for assessing ecosystem impairment: improving certainty in the decision-making process. *Human Ecol. Risk Assess.*, 8, 1675-1696.
- Burton, G.A., Baird, D.J., Culp, J.M., Maltby, L. (2005). *In Situ-Based Effects Measures: Linking Responses to Ecological Consequences in Aquatic Ecosystems*. Allen Press, Lawrence, KS, USA.
- Cairns, M.A., Nebeker, A.V., Gakstatter, J.H., and Griffis, W.L. (1984) Toxicity of copper-spiked sediments to freshwater invertebrates. *Environ. Toxicol. Chem* 3, 435-445.
- CANOCO (2002). *CANOCO for Windows, Version 4 software for canonical community ordination*. Centre for Biometry Wageningen (Wageningen, NL) Microcomputer Power, Ithaca, NY, USA).
- Carignan, R. (1984). Interstitial water sampling by dialysis: Methodological notes. *Limnol. Oceanogr.*, 29, 667-670.
- Carignan, R., Rapin, F., and Tessier, A. (1985). Sediment pore water sampling for metal analysis: A comparison of techniques. *Geochim. Cosmochim. Acta*, 49, 2493-2497.
- Carr, R.S. (1998). Marine and estuarine porewater toxicity testing. In: *Microscale Testing in Aquatic Toxicology: Advances, Techniques, and Practice*, Wells, P.G., Lee, K., and Blaise, C., (editors), CRC Press, Boca Raton, FL., pp. 523-538.
- Carr, R.S., and Chapman, D.C. (1995). Comparison of methods for conducting marine and estuarine sediment porewater toxicity tests - Extraction, storage, and handling techniques. *Archiv. Environ. Contam. Toxicol.*, 28, 69-77.
- Carr, R.S., and Nipper, M.J. (2003). Porewater toxicity testing. *Society of Environmental Toxicity and Chemistry (SETAC)*, Pensacola, FL, USA.
- Chapman, P.M. (1990). The Sediment Quality Triad approach to determining pollution induced degradation. *Sci. Total. Environ.*, 97, 815-835.
- Chapman, P.M. (1996). Presentation and interpretation of the Sediment Quality Triad data. *Ecotoxicology*, 5, 327-339.
- Chapman, P.M., and Wang, F.Y. (2001). Assessing sediment contamination in estuaries. *Environ. Toxicol. Chem.*, 20, 3-22.
- Chapman, P.M., McDonald, B.G., and Lawrence, G.S. (2002a). Weight of evidence issues and frameworks for sediment quality (and other) assessments. *Human Ecol. Risk assess.*, 8, 1489-1516.
- Chapman, P.M., Wang, F., Adams, W.J., and Green, A. (1999). Appropriate application of sediment quality values for metals and metalloids. *Environ. Sci. Technol.*, 33, 3937-3941.
- Chapman, P.M., Wang, F.Y., Germano, J.D., and Batley, G.E. (2002b). Pore water testing and analysis: the good, the bad, and the ugly. *Mar. Pollut. Bull.*, 44, 359-366.
- Chapman, P.M., Wang, F.Y., Janssen, C., Persoone, G., and Allen, H.E. (1998). Ecotoxicology of metals in aquatic sediments: binding and release, bioavailability, risk assessment, and remediation. *Can. J. Fisheries Aquat. Sci.*, 55, 2221-2243.
- Chappie, D.J., and Burton, G.A. (2000). Applications of aquatic and sediment toxicity testing in situ. *Soil Sed. Contam.*, 9, 219-245.
- Chen, Z., and Mayer, L. M. (1999). Sedimentary metal bioavailability determined by the digestive constraints of marine deposit feeders: gut retention time and dissolved amino acids. *Mar. Ecol. Progr. Ser.*, 176, 139-151.
- Chin, Y., and Gschwend, P.M. (1991). The abundance, distribution, and configuration of pore water organic colloids in recent sediment. *Geochim. Cosmochim. Acta*, 55, 1309-1317.
- Ciarelli, S., Van Straalen, N.M., Klap, V.A., and Van Wezel, A.P. (1999). Effects of sediment bioturbation by the estuarine amphipod *Corophium volutator* on fluoranthene resuspension and transfer into the mussel (*Mytilus edulis*). *Environ. Toxicol. Chem.*, 18, 318-328.
- Ciutat, A., and Boudou, A. (2003). Bioturbation effects on cadmium and zinc transfers from a contaminated sediment and on metal bioavailability to benthic bivalves. *Environ. Toxicol. Chem.*, 22, 1574-1581.
- Clarke K.R., and Warwick R.M. (1994). *Changes in marine communities: an approach to statistical analysis and interpretation*, Plymouth Marine Laboratory, Plymouth, UK.
- Cline, J.D. (1969). Spectrophotometric determination of hydrogen sulfide in natural waters. *Limnol. Oceanogr.*, 14, 454-458.
- Cochran W.G., and Cox G.M. (1957). *Experimental designs*. Wiley and Sons, Princeton.
- Cole, F.A., Boese, B.L., Swartz, R.C., Lamberson, J.D., and DeWitt, T.H. (2000). Effects of storage on the toxicity of sediments spiked with fluoranthene to the amphipod, *Rhepoxynius abronius*. *Environ. Toxicol. Chem.*, 19, 744-748.

- Cook N.H., and Wells P.G. (1996). Toxicity of Halifax Harbour sediments: an evaluation of the Microtox® solid-phase test. *Water Qual. Res. J. Canada*, 31, 673-708.
- Cooper, D.C., and Morse, J.W. (1998). Biogeochemical controls on trace metal cycling in anoxic sediments. *Environ. Sci. Technol.*, 32, 327-330.
- Cornelissen, G., van Noort, P.C.M., and Govers, H.A.J. (1997). Desorption kinetics of chlorobenzenes, polycyclic aromatic hydrocarbons, and polychlorinated biphenyls: sediment extraction with tenax® and effects of contact time and solute hydrophobicity. *Environ. Toxicol. Chem.* 16, 1351-1357.
- Cornelissen, G., Rigterink, H., ten Hulscher, D.E.M., Vrind, B.A., van Noort, P.C.M. (2001). A simple Tenax® extraction method to determine the availability of sediment-sorbed organic compounds. *Environ. Toxicol. Chem.*, 20, 706-711.
- Côte C., Balise C., Michaud J., Ménard L., Trottier S., Gagné F., and Lifshitz R. (1998). Comparisons between microscale and whole-sediment assays for freshwater sediment toxicity assessment. *Environ. Toxicol. Water Qual.*, 13, 93-110.
- Dauer D.M. (1993). Biological criteria, environmental health and estuarine macrobenthic community structure. *Mar. Pollut. Bull.*, 26, 249-257.
- Day K.E., Dutka B.J., Kwan K.K., Batista N., Reynoldson T.B., and Metcalfe-Smith J.L. (1995). Correlations between solid-phase microbial screening assays, whole-sediment toxicity tests with macro-invertebrates and in situ benthic community structure. *J. Great Lakes Res.*, 21 192-206.
- Defoe, D.L., and Ankley, G.T. (1998). Influence of storage time on toxicity of freshwater sediments to benthic macroinvertebrates. *Environ. Pollut.*, 99, 123-131.
- DeWitt, T.H., Ozretich, R.J., Swartz, R.C., Lamberson, J.O., Schults, G.R., Ditsworth, D.W., Jones, J.K., Hoselton, L., and Smith, L.M. (1992). The influence of organic matter quality on the toxicity and partitioning of sediment-associated fluoranthene. *Environ. Toxicol. Chem.*, 11, 197-208.
- Di Toro, D.M., Allen, H.E., Bergman, H.L., Meyer, J.S., Paquin, P.R., and Santore, R.C. (2001). Biotic ligand model of the acute toxicity of metals. 1. Technical basis. *Environ. Toxicol. Chem.*, 20, 2383-2396.
- Di Toro, D.M., Mahony, J.D., Hansen, D.J., Scott, K.J., Carlson, A.R., and Ankley, G.T. (1992). Acid volatile sulfide predicts the acute toxicity of cadmium and nickel in sediments. *Environ. Sci. Technol.*, 26, 96-101.
- Di Toro, D.M., Mahony, J.D., Hansen, D.J., Scott, K.J., Hicks, M.B., Mayr, S.M., and Redmond, M.S. (1990). Toxicity of cadmium in sediments: The role of acid volatile sulfide. *Environ. Toxicol. Chem.*, 9, 1487-1502.
- Di Toro, D.M., and McGrath, J.A. (2000). Technical basis for narcotic chemicals and polycyclic aromatic hydrocarbon criteria. II. Mixtures and sediments. *Environ. Toxicol. Chem.*, 19, 1971-1982.
- Di Toro D.M., McGrath J.A., and Hansen D.J. (2000). Technical basis for narcotic chemicals and polycyclic aromatic hydrocarbon criteria. I. Water and tissue. *Environ. Toxicol. Chem.*, 19, 1951-1970.
- Di Toro, D.M., Zarba, C.S., Hansen, D.J., Berry, W.J., Swartz, R.C., Cowan, C.E., Pavlou, S.P., Allen, H.E., Thomas, N.A. and Paquin, P.R. (1991). Technical basis for establishing sediment quality criteria for nonionic organic chemicals using equilibrium partitioning. *Environ. Toxicol. Chem.*, 10, 1541-1583.
- Diamond, S.A., Milrov, N.J., Mattson, V.R., Heinis, L.J., and Mount, D.R. (2003). Photoactivated toxicity in amphipods collected from polycyclic aromatic hydrocarbon-contaminated sites. *Environ. Toxicol. Chem.*, 22, 2752-60.
- Dorsey J., Yentsch C.M., Mayo S., and McKenna C. (1989). Rapid analytical technique for the assessment of cell metabolic activity in marine microalgae. *Cytometry*, 10, 622-628.
- Driscoll, S.K., and Landrum, P.F. (1997). A comparison of equilibrium partitioning and critical body residue approaches for predicting toxicity of sediment-associated fluoranthene to freshwater amphipods. *Environ. Toxicol. Chem.*, 16, 2179-2186
- Echols, K.R., Gale, R.W., Schwartz, T.R., Huckins, J.N., Williams, L.L., Meadows, J.C., Morse, D., Petty, J.D., Orazio, C.E., and Tillitt, D.E. (2000). Comparing polychlorinated biphenyl concentrations and patterns in the Sagnaw River using sediment, caged fish, and semi-permeable membrane devices. *Environ. Sci. Technol.*, 34, 4095-4102.
- El-Alawi, Y.S., Huang, Z.-D., Dixon, G., and Greenberg, B.M. (2002). Quantitative structure-activity relationship for the photoinduced toxicity of polycyclic aromatic hydrocarbons to the luminescent bacteria *Vibrio fischeri*. *Environ. Toxicol. Chem.*, 21, 2225-2232.
- Ellis, J., Cummings, V., Hewitt, J., Thrush S., and Norkko A. (2002). Determining effects of suspended sediment on condition of a suspension feeding bivalve (*Atrina zelandica*): Results of a survey, a laboratory experiment and a field transplantation experiment. *J. Exp. Mar. Biol. Ecol.*, 267, 147-174.
- Environment Australia (2002). National ocean disposal guidelines for dredged material. Commonwealth of Australia, Canberra, ACT.
- Environment Canada (1990). Guidance document on control of toxicity test precision using reference toxicants. Environment Canada Environmental Protection Series. Report EPS 1/RM/12, 85 pp.
- Environment Canada (1992a). Biological test method: acute test for sediment toxicity using marine or estuarine amphipod. Environment Canada Environmental Protection Series, Report EPS 1/RM/26, Ottawa, ON, Canada, 83 pp.
- Environment Canada (1992b). Biological test method: toxicity test using luminescent bacteria (*Photobacterium phosphoreum*). Environment Canada Environmental Protection Series, Report EPS 1/RM/24, Ottawa, ON, Canada, 61 pp.
- Environment Canada (1994). Guidance document on collection and preparation of sediments for physico-chemical characterization and biological testing. Environment Canada Environmental Protection Series. Report EPS 1/RM/29, Ottawa, ON, Canada, 132 pp.

- Environment Canada (1995). Guidance document on measurement of toxicity test precision using control sediment spiked with a reference toxicant. Environment Canada Environmental Protection Series Report EPS 1/RM/30, Ottawa, ON, Canada.
- Environment Canada (1998). Biological test method: Reference method for determining acute lethality of sediments to marine or estuarine amphipods. Method Development and Application Section, Environment Canada Environmental Protection Series, EPS 1/RM/35, Ottawa, ON, Canada.
- Environment Canada (1999). Guidance document on application and interpretation of single-species tests in environmental toxicology. Environment Canada Environmental Protection Series, EPS 1/RM/34, Ottawa, ON, Canada, 203 pp.
- Environment Canada (2002). Biological test method: Reference method for determining the toxicity of sediment using luminescent bacteria in a solid-phase test. EPS 1/RM/42, Ottawa, ON, Canada, 60 pp.
- Ferraro S.P., and Cole F.A. (1990). Taxonomic level and sample size sufficient for assessing pollution impacts on the Southern California Bight macrobenthos. *Mar. Ecol. Prog. Ser.*, 67, 251-262.
- Fisher D.J., McGee B.L., Wright D.A., Yonkos L.T., Ziegler G.P., Turley S.D. (2004). The effects of sieving and spatial variability of estuarine sediment toxicity samples on sediment chemistry. *Arch. Environ. Contam. Toxicol.*, 47, 448-455.
- Fleegeer J.W., Carman K.R., and Nisbel R.M. (2003). Indirect effects of contaminants in aquatic ecosystems. *Sci. Total Environ.*, 317, 207-233.
- Florence, T.M., Stauber, J.L., and Ahsanullah, M. (1994). Toxicity of nickel ores to marine organisms. *Sci. Total Environ.*, 148, 139-156.
- Forster, S. (1996). Spatial and temporal distribution of oxidation events occurring below the sediment-water interface. *Mar. Ecol.*, 17, 309-319
- Franklin, N.M., Stauber, J.L., and Lim, R.P. (2001). Development of flow cytometry based algal bioassays for assessing the toxicity of metals in natural waters. *Environ. Toxicol. Chem.*, 20, 160-170.
- Gale, S.A., King, C.K., and Hyne, R.V. (2006). Development of a chronic whole-sediment bioassay using the estuarine amphipod, *Melita plumulosa* (Zeidler). *Environ. Toxicol. Chem.* (in preparation).
- Gaston G.R., Rakocinski C.F., Brown S.S., and Cleveland C.M. (1998). Trophic function in estuaries: response of macrobenthos to natural and contaminant gradients. *Mar. Freshwater Res.*, 49, 833-846.
- Geffard O., His E., Budzinski H., Chiffolleau J.F., Coynel A., and Etcheber H. (2004). Effects of storage method and duration on the toxicity of marine sediments to embryos of *Crassostrea gigas* oysters. *Environ. Pollut.*, 129, 457-465.
- Glasby, C.J., Hutchings, P.A., Fauchald, K., Paxton, H., Rouse, G.W., Watson Russell, C., and Wilson, R.S. (2000). Class Polychaeta (Chapter 1). In: *Polychaetes and their allies: The Southern Synthesis. Fauna of Australia. Vol 4A Polychaeta, Myzostomida, Pogonophora, Echiura, Sipuncula, Beesley, P.L., Ross, C.J.B., and Glasby, C.J., (editors), CSIRO Publishing, Melbourne, pp. 1-296.*
- Gonzalez, A.M. (1996). A laboratory-formulated sediment incorporating synthetic acid-volatile sulfide. *Environ. Toxicol. Chem.*, 15, 2209-2220.
- Goodyear, K.L., and McNeill, S. (1999). Bioaccumulation of heavy metals by aquatic macro-invertebrates of different feeding guilds: a review. *Sci. Total Environ.*, 229, 1-19.
- Grapentine, L., Anderson, J., Boyd, D., Burton, G.A., DeBarros, C., Johnson, G., Marvin, C., Milani, D., Painter, S., Pascoe, T., Reynoldson, T., Richman, L., Solomon, K., and Chapman, P.M. (2002). A decision-making framework for sediment assessment developed for the Great Lakes. *Human Ecol. Risk Assess.*, 8, 1641-1656.
- Grasshoff, K., Ehrhardt, M., and Kremling, K. (1983). *Methods for seawater analysis.* Verlag Chemie, Weinheim, 2nd Edition, 419 pp.
- Gray J.S. (1989). Effects of environmental stress on species rich assemblages. *Biol. J. Linnean Soc.*, 37, 19-32.
- Guerra-Garcia, J.M., Gonzalez-Vila, F.J., and Garcia-Gomez, J.C. (2003). Aliphatic hydrocarbon pollution and macrobenthic assemblages in Ceuta harbour: A multivariate approach. *Mar. Ecol. Prog. Ser.*, 263, 127-138.
- Guerrero, N.R.V., Taylor, M.G., Wider, E.A., and Simkiss, K. (2003). Influence of particle characteristics and organic matter content on the bioavailability and bioaccumulation of pyrene by clams. *Environ. Pollut.*, 121, 115-122.
- Gunthorpe, L, Nottage, M., Palmer, D. and Wu, R. (1997). Development and validation of a fertilization inhibition bioassay using gametes of *Hormosira banksii*. National Pulp Mills Research Program Technical Report Series No. 21, CSIRO, Canberra, 84 pp.
- Gustafsson, O., Bucheli, T.D., Kukulska, Z., Andersson, M., Largeau, C., Rouzaud, J.-N., Reddy, C.M., and Eglinton, T. (2001). Evaluation of a protocol for the quantification of black carbon in sediments. *Glob. Biogeochem. Cycl.*, 15, 881-890.
- Gustafsson, O., Haghesta, F., Chan, C., MacFarlane, J., and Gschwend, P.M. (1997). Quantification of the dilute sedimentary soot phase: Implication for PAH speciation and bioavailability. *Environ. Sci. Technol.*, 31, 203-209.
- Hall, N.E., Fairchild, J.F., La Point, T.W., Heine, P.R., Ruessler, D.S., and Ingersoll, C.G. (1996). Problems and recommendations in using algal toxicity testing to evaluate contaminated sediments. *J. Great Lakes Res.*, 22, 545-556.
- Hare, L., Tessier, A., and Borgmann, U. (2003). Metal sources for freshwater invertebrates: Pertinence for risk assessment. *Human Ecol. Risk Assess.*, 9, 779-793.
- Heinis, L.J., Highland, T.L., and Mount, D.R. (2004). Method for testing the aquatic toxicity of sediment extracts for use in identifying organic toxicants in sediments *Environ. Sci. Technol.*, 38, 6256-6262.
- Hendriks, A.J., van der Linde, A., Cornelissen, G., and Sijm, D.T.H.M. (2001). The power of size. 1. Rate constants and equilibrium ratios for accumulation of organic substances related to octanol-water partition ratio and species weight. *Environ. Toxicol. Chem.*, 20, 1399-1420.
- Ho, K.T., Burgess, R., Pelletier, M.C., Serbst, J.R., Ryba, S.A., Cantwell, M.G., Kuhn, A., and Raczelowski, P. (2002). An overview of toxicant identification in sediments and dredged materials. *Mar. Poll. Bull.*, 44, 286-293.

- Ho, K.T., Burgess, R.M., Pelletier, M.C., Serbst, J.R., Cook, H., Cantwell, M.G., Ryba, S.A., Perron, M. M., Lebo, J., Huckins, J., and Petty, J. (2004). Use of powdered coconut charcoal as a toxicity identification and evaluation manipulation for organic toxicants in marine sediments. *Environ. Toxicol. Chem.*, 23, 2124-2131.
- Ho, K.T., Kuhn, A., Pelletier, M.C., Burgess, R.M., and Helmstetter, A. (1999). Use of *Ulva lactuca* to distinguish pH-dependent toxicants in marine waters and sediments. *Environ. Toxicol. Chem.*, 18, 207-212.
- Ho, K.T., McKinney, R.A., Kuhn, A., Pelletier, M.C., and Burgess, R.M. (1997). Identification of acute toxicants in New Bedford Harbor sediments. *Environ. Toxicol. Chem.*, 16, 551-558.
- Hsieh, Y.P., Chung, S.W., Tsau, Y.J., and Sue, C.T. (2002). Analysis of sulfides in the presence of ferric minerals by diffusion methods. *Chem. Geol.*, 182, 195-201.
- Hulbert, M.H., and Brindell, M.P. (1975). Effects of sample handling on the composition of marine sedimentary pore water. *Geol. Soc. Amer. Bull.*, 86, 109-110.
- Hyland J.L., Balthis W.L., Hackney C.T., and Posey M. (2000). Sediment quality of North Carolina estuaries: and integrative assessment of sediment contamination, toxicity, and condition of benthic fauna. *J. Aquat. Ecosys. Stress Recov.*, 8, 107-124.
- Hyne, R.V., and Everett, D.A. (1998). Application of a benthic euryhaline amphipod, *Corophium* sp. as a sediment toxicity testing organism for both freshwater and estuarine systems. *Arch. Environ. Contam. Toxicol.*, 34, 26-33.
- Hyne, R.V., Hogan, A., Pablo, F., and Roach, A.C. (2002). Toxicity of selenomethionine and seleno-contaminated sediment to the amphipod, *Corophium* sp. *Ecotoxicol. Environ. Saf.*, 52, 30-37.
- Isidori, M., Lavorgna, M., Nardelli, A., and Parrella, A. (2003). Toxicity identification evaluation of leachates from municipal solid waste landfills: a multispecies approach. *Chemosphere*, 52, 85-94.
- Johnson, D.H.J. (1999). The insignificance of statistical testing. *J. Wildlife Manag.*, 63, 763-772.
- Jones A.R., Watson-Russell C.J., and Murray, A. (1986). Spatial patterns in the macrobenthic communities of the Hawkesbury Estuary, New South Wales. *Aust. J. Mar. Freshwater Res.*, 37:521-543.
- Jung, R.F., and Batley, G.E. (2004). Freezing of sediments inappropriate for pore water selenium analysis. *Mar. Pollut. Bull.*, 49, 295-298.
- Jung, R.F., Jones, D.R., and Batley, G.E. (2003). Corer-reactors for contaminant flux measurements in sediments. *J. Environ. Qual.*, 32, 1905-1910.
- Kaag, N.H.B.M., Foekema, E.M., Scholten, M.C., and Van Straalen, N.M. (1997). Comparison of contaminant accumulation in three species of marine invertebrates with different feeding habits. *Environ. Toxicol. Chem.*, 16, 837-842.
- Karickhoff, S.W., Carreira, L.A., Melton, C., McDaniel, V.K., Vellino, A.N., and Nate, D.E. (1989). Computer prediction of chemical reactivity: The ultimate SAR. U.S. Environmental Protection Agency Report EPA600/M-89-017, Athens, GA, USA.
- Kelly, B.C., Gobas, F.A.P.C., and McLachlan, M.S. (2004). Intestinal adsorption and biomagnification of organic contaminants in fish, wildlife, and humans. *Environ. Toxicol. Chem.*, 23, 2324-2336.
- Keough M.J., and Quinn G.P. (1991). Causality and the choice of measurements for detecting human impacts in marine environments. *Aust. J. Mar. Freshwater Res.*, 42, 539-554.
- Kevekordes, K., and Clayton, M.N. (1996). Using developing embryos of *Hormosira banksii* (Phaeophyta) as a marine bioassay system. *Int. J. Plant Sci.*, 157, 582-585.
- King, C.K., Dowse, M.C., Simpson S.L., and Jolley, D. (2004). An assessment of five Australian polychaetes and bivalves for use in whole-sediment toxicity tests: toxicity and accumulation of copper and zinc from water and sediment. *Arch. Environ. Contam. Toxicol.*, 47, 314-323.
- King, C.K., Simpson, S.L., Smith, S.V., Stauber, J.L., and Batley, G.E. (2005) Short-term accumulation of Cd and Cu from water, sediment and algae by the amphipod *Melita plumulosa* and the bivalve *Tellina deltoidalis*. *Mar. Ecol. Prog. Series*, 287, 177-188.
- King, C.K., Gale, S.A., Hyne, R.V., Stauber, J.L., Simpson, S.L. (2006a). Sensitivities of Australian and New Zealand amphipods to copper and zinc in waters and spiked-sediments. *Chemosphere* (submitted).
- King, C.K., Gale, S.A., and Stauber, J.L. (2006b). Acute toxicity of metal-contaminated sediments to the benthic amphipod *Melita plumulosa*. *Chemosphere* (submitted).
- King, C.K., Dowse, M.C., and Simpson S.L. (2006c). Development of a whole-sediment toxicity test using the Australian estuarine bivalve *Tellina deltoidalis*. (manuscript in preparation).
- Knezovitch, J.P., and Harrison, F.L. (1987). A new method for determining the concentration of volatile organic compounds in sediment interstitial water. *Bull. Environ. Contam. Toxicol.*, 38:937-940.
- Kosian, P.A., Makynen, E.A., Monson, P.D., Mount, D.R., Spacie, A., Mekenyan, O.G., and Ankley, G.T. (1998). Application of toxicity-based fractionation techniques and structure-activity relationship models for the identification of phototoxic polycyclic aromatic hydrocarbons in sediment pore water. *Environ. Toxicol. Chem.*, 17, 1021-1033.
- Kosian, P.A., West, C.W., Pasha, M.S., Cox, J.S., Mount, D.R., Huggett, R.J., and Ankley, G.T. (1999). Use of non-polar resin for reduction of fluoranthene bioavailability in sediment. *Environ. Toxicol. Chem.*, 8, 201-206.
- Kraaij, R., Mayer, P., Busser, F.J.M., Bolscher, M.V.H., Seinen, W., and Tolls, J. (2003). Measured pore-water concentrations make equilibrium partitioning work - a data analysis. *Environ. Sci. Technol.*, 37, 268-274.
- Krassoi, R. (1996). Adaptation of the 48 h larval abnormality test using the doughboy scallop and Sydney rock oyster to the assessment of sediments. *Proceedings of the International Symposium on Environmental Chemistry and Toxicology, Sydney NSW, 00108.*
- Krassoi, R., Everett, D., and Anderson, I. (1996). protocol for using doughboy scallop *Chlamys asperrima* (Mollusca: Pectinidae) L. to test the sublethal toxicity of single compounds and effluents. *National Pulp Mills Research Program Technical Report Series No. 17, CSIRO, Canberra, 48 pp.*

- Landrum, P.F., Eadie, B.J., and Faust, W.R. (1992). Variation in the bioavailability of polycyclic aromatic hydrocarbons to the amphipod *Diporeia* (spp.) with sediment aging. *Environ. Toxicol. Chem.*, 11, 1197-1208.
- Landrum, P.F., Harkey, G.A., and Kukkonen, J. (1996). Evaluation of organic contaminants exposure in aquatic organisms: The significance of bioconcentration and bioaccumulation. In: *Ecotoxicology: A Hierarchical Treatment*, Newman M.C., Jagoe C.H., (editors), Lewis, Boca Raton, FL, USA, pp 85-131.
- Langezaal, A.M., Ernst, S.R., Haese, R.R., van Bergen, P.F., and van der Zwaan, G.J. (2003). Disturbance of intertidal sediments: the response of bacteria and foraminifera. *Estuar. Coastal Shelf Sci.*, 58, 249-264.
- Lardicci C., and Rossi F. (1998). Detection of stress on macrozoobenthos: evaluation of some methods in a costal Mediterranean lagoon. *Mar. Environ. Res.*, 45, 367-386.
- Lawrence, A.L., McAloon, K.M., Mason, R.P., and Mayer, L.M. (1999). Intestinal solubilization of particle-associated organic and inorganic mercury as a measure of bioavailability to benthic invertebrates. *Environ. Sci. Technol.*, 33, 1871-1876.
- Lee, H., Boese, B.L., Pelletier, J., Winsor, M., Specht, D.T., and Randall, R.C. (1993). Guidance manual: Bedded sediment bioaccumulation tests. US Environmental Protection Agency Report No 600/R-93/183, Narragansett, RI, USA, 231 p.
- Lee, B.G., Griscom, S.B., Lee, J.S., Choi, H.J., Koh, C.H., Luoma, S.N., and Fisher, N.S. (2000a). Influences of dietary uptake and reactive sulfides on metal bioavailability from aquatic sediments. *Science*, 287, 282-284.
- Lee, J.S., Lee, B.G., Luoma, S.N., Choi, H.J., Koh, C.H., and Brown, C.L. (2000b). Influence of acid volatile sulfides and metal concentrations on metal partitioning in contaminated sediments. *Environ. Sci. Technol.*, 34, 4511-4516.
- Lee, J.S., Lee, B.G., Yoo, H., Koh, C.H., and Luoma, S.N. (2001). Influence of reactive sulfide (AVS) and supplementary food on Ag, Cd and Zn bioaccumulation in the marine polychaete *Neanthes arenaceodentata*. *Mar. Ecol. Prog. Ser.*, 216, 129-140.
- Legendre P., and Legendre L. (1998). *Numerical ecology*. Elsevier Science, Amsterdam.
- Leonard, E.N., Cotter, A.M., and Ankley, G.T. (1996). Modified diffusion method for analysis of acid volatile sulfides and simultaneously extracted metals in freshwater sediment. *Environ. Toxicol. Chem.*, 15, 1479-1481.
- Leonard, E.N., Mount, D.R., and G.T. Ankley. (1999). Modification of metal partitioning by supplementing acid volatile sulfide in freshwater sediments. *Environ. Toxicol. Chem.*, 18, 858-864.
- Leppänen, M.T., and Kukkonen, J.V.K. (2000). Effect of sediment-chemical contact time on availability of sediment-associated pyrene and benzo(a)pyrene to oligochaete worms and semipermeable membrane devices. *Aquat. Toxicol.* 49, 227-241.
- Lindegarh, M., and Hoskins, M. (2001). Patterns of distribution of macro-fauna in different types of estuarine, soft-sediment habitats adjacent to urban and non-urban areas. *Estuar. Coastal Shelf Sci.*, 52, 363-373.
- Lowry, J.K. (2004). A new species of *Corophium* from eastern Australian estuaries (Crustacea: Amphipoda: Corophiidae: Corophiinae: Corophiini). *Zootaxa*, 754, 1-10.
- Lowry, J.K., Berents, P.B., and Springthorpe, R.T. (2000) <http://www.crustacea.net/crustace/amphipoda/melitidae/www/plumulo.htm>
- Lowry, J.K. and Stoddart, H.E. (2003). Crustacea: Malacostraca: Syncarida, Peracarida. In: *Zoological Catalogue of Australia*, 19.2a, Houston W.W.K., and Wells, A., (editors), CSIRO Publishing, Melbourne, VIC, Australia.
- Mackay, D., and Fraser, A. (2000). Bioaccumulation of persistent organic chemicals: mechanisms and models. *Environ. Pollut.*, 110, 375-391.
- Mackey, A.P., and Mackay, S. (1996). Spatial distribution of acid-volatile sulfide concentration and metal bioavailability in mangrove sediments from the Brisbane River, Australia. *Environ. Pollut.*, 93, 205-209.
- Matthews R.A., Landis W.G., and Matthews G.B. (1996). The community condition hypothesis and its implication to environmental toxicology. *Environ. Toxicol. Chem.*, 15, 597-603.
- MacRae, J.D., and Hall, K.J. (1998). Comparison of methods used to determine the availability of polycyclic aromatic hydrocarbons in marine sediment. *Environ. Sci. Technol.*, 32, 3809-3815.
- Mapstone, B.D. (1995). Scalable Decision Rules for Environmental Impact Studies: Effect Size, Type I, and Type II Errors. *Ecological Applications*, 5, 401-410.
- Mayer, L., Chen, Z., Findlay, R., Fang, J., Sampson, S., Self, L., Jumars, P., Quetel, C., and Donard, O. (1996). Bioavailability of sedimentary contaminants subject to deposit-feeder digestion. *Environ. Sci. Technol.*, 30, 2641-2645.
- Mayer, P., Vaes, W., Wijnker, F., Legoerse, K., Kraaij, R., Tolls, J., and Hermens, J.J.M. (2000). Sensing dissolved sediment porewater concentrations of persistent and bioaccumulative pollutants using disposable solid phase microextraction fibers. *Environ. Sci. Technol.*, 34, 5177-5183.
- McCready, S., Greely, C.R., Hyne, R.V., Birch, G., Long, E.R., and Spyraakis, G. (2004). Sensitivity of an indigenous amphipod, *Corophium colo*, to chemical contaminants in laboratory toxicity tests conducted with sediments from Sydney Harbour, Australia and vicinity. *Environ. Toxicol. Chem.*, (submitted).
- McDonald, B.G., and Chapman, P.M. (2002). PAH phototoxicity - an ecologically irrelevant phenomenon? *Mar. Pollut. Bull.*, 44, 1321-1326 .
- McGeer, J.C., Brix, K.V., Skeaff, J.M., Deforest, D.K., Brigham, S.I., Adams, W.J., and Green, A. (2003). Inverse relationship between bioconcentration factor and exposure concentration for metals: Implications for hazard assessment of metals in the aquatic environment. *Environ. Toxicol. Chem.*, 22, 1017-1037.
- McGroddy, S., Farrington, J.W., and Gschwend, P.M. (1996). Comparison of the in situ and desorption sediment-water partitioning of polycyclic aromatic hydrocarbons and polychlorinated biphenyls. *Environ. Sci. Technol.*, 30, 172-177.

- Meador, J.P., Stein, J.E., Reichert, W.L., and Varanasi, U. (1995). Bioaccumulation of polycyclic aromatic hydrocarbons by marine organisms. *Rev. Environ. Contam. Toxicol.*, 143, 79-165.
- Menzie, C., Henning, M.H., Cura, J., Finkelstein, K., Gentile, J., Maughan, J., Mitchell, D., Petron, S., Potocki, B., Svirsky, S., and Tyler, P. (1996). Report of the Massachusetts weight-of-evidence workgroup: a weight-of-evidence approach to evaluating ecological risks. *Human Ecol. Risk Assess.*, 2, 277-304.
- Meylan, W.M., Howard, P.H., Boethling, R.S., Aronson, D., Printup, H., and Gouchie, S. (1999). Improved method for estimating bioconcentration/bioaccumulation factor from octanol/water partitioning coefficient. *Environ. Toxicol. Chem.*, 18, 664-672.
- Mistri M., Rossi R., and Fano E.A. (2001). Structure and secondary production of a soft-bottom macrobenthic community in a brackish lagoon (Sacca di Goro, north-eastern Italy). *Estuar. Coast. Shelf Sci.*, 52, 605-616.
- Moore, D.W., Baudo, R., Conder, J.M., Landrum, P.F., McFarland, V.A., Meador, J.P., and Word, J.Q. (2005). Bioaccumulation in the assessment of sediment quality: uncertainty and potential application. In: Use of sediment quality guidelines and related tools for the assessment of contaminated, Wenning, R.J., Batley, G.E., Ingersoll, C.G., and Moore, D.W., (editors), SETAC Press, Pensacola, FL, USA.
- Moore, D.W., Bridges, T.S., Gray, B.R., and Duke, B.M. (1997). Risk of ammonia toxicity during sediment bioassays with the estuarine amphipod *Leptocheirus plumulosus*. *Environ. Toxicol. Chem.*, 16, 1020-1027.
- Moreno-Garrido, I., Hampel, M., Lubian, L.M., and Blasco, J. (2003). Sediment toxicity tests using benthic marine microalgae *Cylindrotheca closterium* (Ehrenberg) Lewin and Reimann (Bacillariophyceae). *Ecotox. Environ. Saf.*, 54, 290-295.
- Morrisey D.J., Howitt L., Underwood A.J., and Stark J.S. (1992a). Spatial variation in soft-sediment benthos. *Mar. Ecol. Prog. Ser.*, 81, 197-204.
- Morrisey D.J., Stark J.S., Howitt L., and Underwood A.J. (1994a). Spatial variation in concentrations of heavy metals in marine sediment. *Aust. J. Mar. Freshwater Res.*, 45, 177-184.
- Morrisey D.J., Turner S.J., Mills G.N., Williamson R.B., and Wise B.E. (2003). Factors affecting the distribution of benthic macrofauna in estuaries contaminated by urban runoff. *Mar. Environ. Res.*, 55, 113-136.
- Morrisey D.J., Underwood A.J., Howitt L., and Stark J.S. (1992b). Temporal variation in soft-sediment benthos. *J. Exp. Mar. Biol. Ecol.*, 164, 233-245.
- Morrisey D.J., Underwood A.J., Stark J.S., and Howitt L. (1994b). Temporal variation in concentrations of heavy metals in marine sediments. *Estuar. Coast. Shelf Sci.*, 38, 271-282.
- Mudroch, A., and Azcue, J.M. (1995). Manual of aquatic sediment sampling. CRC Press, Boca Raton, FL.
- Mudroch, A., Azcue, J.M., and Mudroch, P. (1997). Manual of physico-chemical analysis of aquatic sediments. CRC Press, Boca Raton, FL, USA.
- Munawar M., and Munawar, I.F. (1987). Phytoplankton bioassays for evaluating toxicity of in situ sediment contaminants. *Hydrobiologia*, 149, 87-105.
- Neumann, P.T.M., Borgmann, U., and Norwood, W. (1999). Effect of gut clearance on metal body concentrations in *Hyalella azteca*. *Environ. Toxicol. Chem.*, 18, 976-984.
- NFESC (2003). Using sediment toxicity identification evaluations to improve the development of remedial goals for aquatic habitats. Naval Facility Engineering Services Center, Special Publication SP-2132-ENV.
- Nipper M.G., Roper D.S., Williams E.K., Martin M.L., Van Dam L.F., and Mills G.N. (1998). Sediment toxicity and benthic communities in mildly contaminated mudflats. *Environ. Toxicol. Chem.*, 17, 502-510.
- Northcott, G.L., and Jones, K.C. (2000). Spiking hydrophobic organic compounds into soil. *Environ. Toxicol. Chem.*, 19, 2418-2430.
- O'Day, P.A., Carroll, S.A., Randall, S., Martinelli, R.E., Anderson, S.L., Jelinski, J., and Knezovich, J.P. (2000). Metal speciation and bioavailability in contaminated estuary sediments, Alameda Naval Air Station, California. *Environ. Sci. Technol.*, 34, 3666-3673.
- Paine, M.D. and McPherson, C.A. (1991). Phase IV studies of 10-day tests for sediment toxicity using marine or estuarine infaunal amphipods. Final report by EVS Consultants Ltd, North Vancouver, BC Canada (prepared for Environment Canada).
- PC-ORD (1999). Multivariate analysis of ecological data, MJM Software Design, Gleneden Beach, OR, USA.
- Pelletier, M. C., Burgess, R. M., Cantwell, M. G., Serbst, J. R., Ho, K. T., and Ryba, S. (2000). Importance of maternal transfer of the photoreactive polycyclic aromatic hydrocarbon fluoranthene from benthic adult bivalves to their pelagic larvae. *Environ. Toxicol. Chem.*, 19, 2691-2698.
- Pelletier, M.C., Ho, K.T., Cantwell, M., Kuhn-Hines, A., Jayaraman, S., and Burgess, R.M. (2001). Use of *Ulva lactuca* to identify ammonia toxicity in marine and estuarine sediments. *Environ. Toxicol. Chem.*, 20, 2852-2859.
- Petersen, K., Kristensen, E., and Bjerregaard, P. (1998). Influence of bioturbating animals on flux of cadmium into estuarine sediment. *Mar. Environ. Res.*, 45, 403-415.
- Petty, J.D., Orazio, C.E., Huckins, J.N., Gale, R.W., Lebo, J.A., Meadows, J.C, Echols, K.R., and Cranor W.L. (2000). Considerations involved with the use of semipermeable membrane devices for monitoring environmental contaminants. *J. Chromat. A*, 879, 83-95.
- Ponder, W.F. (1998). Superfamily Galeommatoida. In: Mollusca: The Southern Synthesis. Fauna of Australia. Vol 5, Part B, Beesley, P.L., Ross G.J.B., and Wells, A., (editors), CSIRO Publishing, Melbourne, pp. 316-318.
- Ponder, W.F., Clark, S.A., and Dallwitz, M.J. (2000). Freshwater and estuarine molluscs: An interactive, illustrated key for New South Wales. CSIRO Publishing, Melbourne, Victoria, Australia.
- Primer 5 (2001). Multivariate statistics for ecologists, Primer Enterprises Ltd., Plymouth Marine Laboratories, United Kingdom.
- Quinn G.P., and Keough M.J. (2002). Experimental design and data analysis for biologists, Cambridge University Press, Cambridge, United Kingdom.

- Rainbow, P.S. (2002). Trace metal concentrations in aquatic invertebrates: why and so what? *Environ. Pollut.*, 120, 497-507.
- Rainbow, P.S., Ng, T. Y.-T., Shi, D., and Wang, W.-X. (2004). Acute dietary pre-exposure and trace metal bioavailability to the barnacle *Balanus amphitrite*. *J. Exp. Mar. Biol. Ecol.*, 311, 315-337.
- Rapport D.J., Reigner H.A., and Hutchinson T.C. (1985). Ecosystem behaviour under stress. *Amer. Natural.*, 125: 617-640.
- Rascinski, C, Brown, S., Gaston G., Heard, R., Walker, W., and Summers, J. (1997). Macrobenthic responses to natural and contaminant-related gradients in northern Gulf of Mexico estuaries. *Ecol. Applic.*, 7, 1278-1298.
- Rasmussen, A.D., Banta, G.T., and Andersen, O. (2000). Cadmium dynamics in estuarine sediments: Effects of salinity and lugworm bioturbation. *Environ. Toxicol. Chem.*, 19, 380-386.
- Reynoldson, T.B., Smith, E.P., and Bailer, A.J. (2002). Comparison of three weight of evidence approaches for integrating sediment contaminant data across multiple lines of evidence. *Human Ecol. Risk Assess.*, 8, 1613-1624.
- Roach, A.C., Jones, A.R., and Murray, A. (2001). Using benthic recruitment to assess the significance of contaminated sediments: the influence of taxonomic resolution. *Environ. Pollut.*, 112, 131-143.
- Ross, P. (1993). The use of bacterial luminescence systems in aquatic toxicity testing. In: *Ecotoxicology Monitoring*, Richardson, M., (editor), VCH, Weinheim, Germany. P. 185-195.
- Ross, K.E., and Bidwell, J.R. (2001). A 48-h larval development toxicity test using the marine polychaete *Galeolaria caespitosa* Lamarck (Fam. Serpulidae). *Arch. Environ. Contam. Toxicol.*, 40, 489-496.
- Rowe G.T. (1971). Benthic biomass and surface productivity, In: *Fertility of the Sea*, Costlow, J.D., (editor), Gordon and Breach, New York, pp. 441-454.
- Saiz-Salinas J.I., and Gonzalez-Oreja J.A. (2000). Stress in estuarine communities: lessons from the highly-impacted Bilbao estuary (Spain). *J. Aquat. Ecosyst. Stress Recov.*, 7, 43-55.
- Sanudo-Wihelmy, S.A., Rossi, F.K., Bokuniewicz, H., and Paulsen, R.J. (2002). Trace metal levels in uncontaminated groundwater of a coastal watershed: importance of colloidal forms. *Environ. Sci. Technol.*, 36, 1435-1441.
- Sarda, N., and Burton, G.A. (1995). Ammonia variation in sediments: Spatial, temporal and method-related effects. *Environ. Toxicol. Chem.*, 14, 1499-1506.
- Schindler D.W. (1987). Detecting ecosystem responses to anthropogenic stress. *Can. J. Fish. Aquat. Sci.*, 44, 6-25.
- Shuttleworth, S.M., Davison, W., and Hamilton-Taylor, J. (1999). Two-dimensional and fine structure in the concentrations of iron and manganese in sediment pore-waters. *Environ. Sci. Technol.*, 33, 4169-4175.
- Sijm, R.T.H., Haller, M., and Schrap, S.M., (1997). Influence of storage on sediment characteristics and drying sediment on sorption coefficients of organic contaminants. *Bull. Environ. Contam. Toxicol.*, 58,961-968.
- Simon, J., and Laginestra, E. (1997). Bioassay for testing sublethal toxicity of effluents using gametes of sea urchin *Heliocidaris tuberculata*. National Pulp Mills Research Program Technical Report Series No. 20, CSIRO, Canberra, 30 pp.
- Simpson, S.L. (2001). A rapid screening method for acid-volatile sulfide in sediments *Environ. Toxicol. Chem.*, 20, 2657-2661.
- Simpson, S.L., Angel, B.M., and Jolley, D.F. (2004). Metal equilibration in laboratory-contaminated (spiked) sediments used for the development whole-sediment toxicity tests. *Chemosphere*, 54, 597-609.
- Simpson, S.L., and Batley, G.E. (2003). Disturbances to metal partitioning during toxicity testing Fe(II)-rich estuarine porewaters and whole-sediments. *Environ. Toxicol. Chem.*, 22, 424-432.
- Simpson, S.L., Apte, S.C., and Batley, G.E. (1998). Effect of short term resuspension events on trace metal speciation in polluted anoxic sediments. *Environ. Sci. Technol.*, 32, 620-625.
- Simpson, S.L., Apte, S.C., and Batley, G.E. (2000). Effect of short-term resuspension events on the oxidation of cadmium, lead, and zinc sulfide phases in anoxic estuarine sediments. *Environ. Sci. Technol.*, 34, 4533-4537.
- Simpson, S.L., and King, C.K. (2005). Exposure-pathway models explain causality in whole-sediment toxicity tests. *Environ. Sci. Technol.*, 39, 837-843.
- Smith, E.P., Lipkovich, I, and Ye, K. (2002). Weight of evidence (WOE): quantitative estimation of probability of impairment for individual and multiple lines of evidence. *Human Ecol. Risk Assess.*, 8, 1585-1596.
- Somerfield P.J., and Clarke K.R. (1995). Taxonomic levels, in marine community studies, revisited. *Mar. Ecol. Prog. Ser.*, 127, 113-119.
- Stark, J.S. (1998). Heavy metal pollution and macrobenthic assemblages in soft sediments in two Sydney estuaries. *Aust. J. Mar. Freshwater Res.* 49, 533-540.
- Stauber, J.L., Tsai, J., Vaughan, G., Peterson, S.M., and Brockbank, C.I. (1994). Algae as indicators of toxicity of BEKM effluents. National Pulp Mills Research Program Technical Report Series No. 3, CSIRO, Canberra, 82 pp.
- Stauber, J., Adams, M., and Simpson, S. (2004). Use of flow cytometry in marine sediment toxicity testing with benthic microalgae. *SETAC Globe Jan-Feb* 31-33.
- Stemmer, B.L., Burton, G.A., and Leibfritz-Frederick, S. (1990a). Effect of sediment test variables on selenium toxicity to *Daphnia magna*. *Environ. Toxicol. Chem.*, 9, 381-389.
- Stemmer, B.L., Burton, G.A., and Sasson-Brickson, G. (1990b). Effect of sediment spatial variance and collection method on cladoceran toxicity and indigenous microbial activity determinations. *Environ. Toxicol. Chem.*, 9, 1035-44.
- Steward N., Martin R., Engasser J.M., and Goergen J.L. (1999). A new methodology for plant cell viability assessment using intracellular esterase activity. *Plant Cell Rep.*, 19, 171-179.

- St-Laurent D. and Blaise C.R. (1995). Validation of a microplate-based algal lethality test developed with the help of flow cytometry. In: Environmental Toxicology Assessment, Richardson, M., (editor), Taylor and Francis, London, United Kingdom, pp. 137-155.
- Stokie, T., Duda, S., and Gunthorpe, L. (2004). Protocol for using *Australonereis ehlersi* to assess the toxicity of contaminated sediments. Environmental Health and Chemistry Report No 32 . PIRVic, Queenscliff, Australia.
- Stronkhorst, J., Schot, M.E., and Dubbeldam, M.C., and Ho, K.T. (2003). A toxicity identification evaluation of silty marine harbor sediments to characterize persistent and non-persistent constituents. Mar. Pollut. Bull., 46, 56-64.
- Stumm, W., and Sulzberger, B. (1992). The cycling of iron in natural environments: considerations based on laboratory studies of heterogeneous redox processes. Geochim. Cosmochim. Acta, 56, 3233-3257.
- Surtikanti ,H.K., Hyne, R.V., Everett, D.A., and Lim, R.P. (1998). Population density and breeding periodicity of the amphipod *Corophium* sp., in the Hawkesbury River. Australas. J. Ecotox., 4,85-91.
- Surtikanti, H.K., and Hyne, R.V. (2000). Sediment toxicity testing using the amphipod *Corophium* sp: Standardisation of test conditions for an acute survival test and a sub-chronic growth test in freshwater. Australas. J. Ecotox., 6, 11-20.
- Suter, G.W. (1993). Ecological risk assessment. Lewis Publishers, Boca Raton, FL, USA.
- Swartz, R.C., Ditsworth, G.R., Schults, D.W. and Lamberson, J.O. (1985). Sediment toxicity to a marine infaunal amphipod: cadmium and its interaction with sewage sludge. Mar. Environ. Res.18, 133-153.
- Swartz, R.C., Ferraro, S.P., Lamberson, J.O., Cole, F.A., Ozretich, R.J., Boese, B.L., Schults, D.W., Behrenfeld, M., and Ankley, G.T. (1997). Photoactivation and toxicity of mixture of polycyclic aromatic hydrocarbon compounds in marine sediments. Environ. Toxicol. Chem., 16, 2151-2157.
- Teasdale, P.R., Batley, G.E., Apte, S.C., and Webster, I.T. (1995). Pore water sampling with sediment peepers. Trends Anal. Chem., 14, 250-256.
- ten Hulscher, T.E.M., Postma, J., den Besten, P.J., Stroomborg, G.J., Belfroid, A., Wegener, J.W., Faber, J.H., van der Pol, J.J.C., Hendriks, A.J. and van Noort, P.C.M. (2003). Tenax extraction mimics benthic and terrestrial bioavailability of organic compounds Environ. Toxicol. Chem., 22, 2258-2265.
- Ter Braak (1995). Ordination. In: Data Analysis in Community and Landscape Ecology, Jongman, R.G.H., Ter Braak, C.J.F., and Van Tongeren, O.F.R., (editors), Cambridge University Press, Cambridge, United Kingdom, pp. 91-173.
- Thomson, E.A., Luoma, S.N., Cain, D.J., and Johansson, C. (1980). The effect of sample storage on the extraction of Cu, Zn, Fe, Mn and organic material from oxidised estuarine sediments. Water Air Soil Pollut., 14, 215-233.
- Tsvetnenko, Y.B., Black, A.J., and Evans, L.E. (2000). Development of marine sediment reworker tests with Australian species for toxicity assessment of drilling mud. Environ. Toxicol. 15, 540-548.
- Underwood, A.J. (1991). Beyond BACI: experimental designs for detecting human environmental impacts on temporal variations in natural populations. Aust. J. Mar. Freshwater Res., 42, 569-588.
- Underwood, A.J. (1994). Things environmental scientists (and statisticians) need to know to receive (and give) better statistical advice. In: Statistics in Ecology and Environmental Monitoring, Fletcher, D.J., and Manly, B.J., (editors), University of Otago Press, Dunedin, New Zealand, pp. 33-61.
- Underwood A.J. (1997). Experiments in ecology: their logical design and interpretation using analysis of variance. Cambridge University Press, Cambridge, United Kingdom.
- Underwood A.J. (2000). The importance of experimental design in detecting and measuring stress in marine populations. J. Aquat. Ecosys. Stress Recov., 7, 3-24.
- USACE/USEPA (2002). US Army Corps of Engineers/US Environmental Protection Agency. Environmental Residue Effects Database (ERED). <http://el.erdc.usace.army.mil/ered/>
- USEPA (1994). Methods for measuring the toxicity of sediment-associated contaminants with estuarine and marine amphipods. U.S. Environmental Protection Agency Report EPA-600/R-94/025, Narragansett, RI, USA.
- USEPA (2000a). Bioaccumulation testing and interpretation for the purpose of sediment quality assessment: Status and needs. U.S. Environmental Protection Agency Report Office of Water Report EPA-823-R-00-002, Wshahington, DC, USA.
- USEPA (2000b). Appendix to bioaccumulation and testing interpretation for the purposes of sediment quality assessment: Status and needs: Chemical-specific summary tables. U.S. Environmental Protection Agency Report Office of Water Report EPA-823-R-00-002, Wshahington, DC, USA.
- USEPA (2000c). Stressor identification guidance document. U.S. Environmental Protection Agency Report EPA/822/B-00-025, Office of Water and Office of Research and Development, Office of Water, Washington, DC, USA.
- USEPA (2000d). Guidance on choosing a sampling design for environmental data collection for use in developing a quality assurance project plan. U.S. Environmental Protection Agency Report EPA/240/R-02/005, Narragansett, RI, USA.
- USEPA (2000e). Estuarine and coastal marine waters: bioassessment and biocriteria technical guidance. U.S. Environmental Protection Agency Report EPA-822-B-00-024, Washington, DC, USA
- USEPA (2001). Methods for Collection, Storage and Manipulation of Sediments for Chemical and Toxicological Analyses, U.S. Environmental Protection Agency Technical Manual EPA-823-B-01-002, Office of Water, Washington, DC, USA.
- USEPA/USACE (1998). Evaluation of dredged material proposed for discharge in waters of the U.S. U.S. Environmental Protection Agency/Army Corps of Engineers Testing Manual EPA-823-B-98-004, Washington, DC, USA.
- Veith, G.D., Mekenyan, O.G., Ankley, G.T., and Call, D.J. (1995). A QSAR analysis of substituent effects on the photoinduced acute toxicity of PAHs. Chemosphere, 30, 2129-2142.

- Verbruggen, E.M.J., Vaes, W.H.J., Parkerton, T.F., and Hermens, J.L.M. (2000). Polyacrylate-coated SPME fibers as a tool to simulate body residues and target concentrations of complex organic mixtures for estimation of baseline toxicity. *Environ. Sci. Technol.*, 34, 324-331.
- Verrhiest, G.J., Cortes, S., Clément, B., and Montuelle, B. (2002). Chemical and bacterial changes during laboratory conditioning of formulated and natural sediments. *Chemosphere*, 46, 961-974.
- Vijver, M.C., van Gestel, C.A.M., Lanno, R.P., van Straalen, N.M., and Peijnenburg, W.J.G.M. (2004). Internal metal sequestration and its ecological relevance: a review. *Env. Sci. Technol.*, 38, 4705-4711.
- Vink, J.P.M. (2002). Measurement of heavy metal speciation over redox gradients in natural water-sediment interfaces and implications for uptake by benthic organisms. *Environ. Sci. Technol.*, 36, 5130-5138.
- Vinturella, A.E., Burgess, R.M., Coull, B.A., Thompson, K.M., and Shine, J.P. (2004). Use of passive samplers to mimic uptake of polycyclic aromatic hydrocarbons by benthic polychaetes. *Env. Sci. Technol.*, 38, 1154-1160.
- Voparil, J. M., and Mayer, L. M. (2004). Commercially available chemicals that mimic a deposit feeder's (*Arenicola marina*) digestive solubilization of lipids. *Environ. Sci. Technol.*, 38, 4334-4339.
- Voparil, J.M., Burgess, R.M., Mayer, L.M., Tien, R., Cantwell, M.G., and Ryba, S.A. (2004). Digestive bioavailability of a deposit feeder (*Arenicola marina*) of polycyclic aromatic hydrocarbons associated with anthropogenic particles. *Environ. Toxicol. Chem.*, 23, 2618-2626.
- Wang, W.X. (2002). Interactions of trace metals and different marine food chains. *Mar. Ecol. Prog. Ser.*, 243, 295-309.
- Wang, F.Y., and Chapman, P.M. (1999). Biological implications of sulfide in sediment - A review focusing on sediment toxicity. *Environ. Toxicol. Chem.*, 18, 2526-2532.
- Wang, W.X., and Fisher, N.S. (1999a). Assimilation efficiencies of chemical contaminants in aquatic invertebrates: A synthesis. *Environ. Toxicol. Chem.*, 18, 2034-2045.
- Wang, W.X., and Fisher, N.S. (1999b). Delineating metal accumulation pathways for marine invertebrates. *Sci. Total Environ.*, 238, 459-472.
- Wang, W.X., and Ke, C.H. (2002). Dominance of dietary intake of cadmium and zinc by two marine predatory gastropods. *Aquatic Toxicol.*, 56, 153-165.
- Warwick, R.M. (1988). Analysis of community attributes of the macrobenthos of Frierfjord/Langesundfjord at taxonomic levels higher than species. *Mar. Ecol. Prog. Ser.*, 46, 167-170.
- Warwick, R.M. (1993). Environmental studies on marine communities: pragmatical considerations. *Aust. J. Ecol.*, 18, 63-80.
- Washington, H.G. (1984). Diversity, biota and similarity indices. *Water Res.*, 18, 653-694.
- Wenning, R.J., Batley, G.E., Ingersoll, C.G., and Moore, D.W. (2005). Use of sediment quality guidelines and related tools for the assessment of contaminated sediments. SETAC Press, Pensacola, FL, USA.
- Weston, D.P., and Maruya, K.A. (2002). Predicting bioavailability and bioaccumulation with in vitro digestive fluid extraction. *Environ. Toxicol. Chem.*, 21, 962-971.
- Weston, D.P., and Mayer, L.M. (1998). Comparison of in vitro digestive fluid extraction and traditional in vivo approaches as measures of polycyclic aromatic hydrocarbon bioavailability from sediments. *Environ. Toxicol. Chem.*, 17, 830-840.
- Weston, D.P., Penry, D.L., Gulmann, L.K. (2000). The role of ingestion as a route of contaminant bioaccumulation in a deposit-feeding polychaete. *Arch. Environ. Contam. Toxicol.*, 38, 446-454.
- White, D.S. (1988). Persistent toxic substances and zoobenthos in the Great Lakes. In: *Toxic Contaminants and Ecosystem Health: A Great Lakes Focus*, Evans, M.S., (editor), John Wiley and Sons, New York, pp. 537-548.
- Willan, R.C. (1998). Superfamily Tellinoidea. In: *Mollusca: The Southern Synthesis, Fauna of Australia. Vol 5, Part B*, Beesley, P.L., Ross, G.J.B., and Wells, A., (editors) CSIRO Publishing, Melbourne, pp. 342-348.
- Wu R.S. (1982). Periodic defaunation and recovery in a subtropical epibenthic community, in relation to organic pollution. *J. Exp. Mar. Biol. Ecol.*, 64, 253-269.
- Ysebaert, T., and Herman, P. (2002) Spatial and temporal variation in benthic macrofauna and relationships with environmental variables in an estuarine, intertidal soft-sediment environment. *Mar. Ecol. Prog. Ser.*, 244, 105-124.

APPENDIX 1. ANZECC/ARMCANZ INTERIM SEDIMENT QUALITY GUIDELINES

Table A1. Recommended sediment quality guidelines (ANZECC/ARMCANZ, 2000a)

Contaminant	ISQG-Low (Trigger value)	ISQG-High
METALS (mg/kg dry wt)		
Antimony	2	25
Cadmium	1.5	10
Chromium	80	370
Copper	65	270
Lead	50	220
Mercury	0.15	1
Nickel	21	52
Silver	1	3.7
Zinc	200	410
METALLOIDS (mg/kg dry wt)		
Arsenic	20	70
ORGANOMETALLICS		
Tributyltin ($\mu\text{g Sn/kg dry wt}$)	5	70
ORGANICS ($\mu\text{g/kg dry wt}$) ^a		
Acenaphthene	16	500
Acenaphthalene	44	640
Anthracene	85	1100
Fluorene	19	540
Naphthalene	160	2100
Phenanthrene	240	1500
Low Molecular Weight PAHs ^b	552	3160
Benzo(a)anthracene	261	1600
Benzo(a)pyrene	430	1600
Dibenzo(a,h)anthracene	63	260
Chrysene	384	2800
Fluoranthene	600	5100
Pyrene	665	2600
High Molecular Weight PAHs ^b	1700	9600
Total PAHs	4000	45000
Total DDT	1.6	46
p,p'-DDE	2.2	27
o,p'- + p,p'-DDD	2	20
Chlordane	0.5	6
Dieldrin	0.02	8
Endrin	0.02	8
Lindane	0.32	1
Total PCBs	23	-

^aNormalised to 1% organic carbon; ^bLow molecular weight PAHs are the sum of acenaphthene, acenaphthalene, anthracene, fluorene, 2-methylnaphthalene, naphthalene and phenanthrene; high molecular weight PAHs are the sum of benzo(a)anthracene, benzo(a)pyrene, chrysene, dibenzo(a,h)anthracene, fluoranthene and pyrene

APPENDIX 2. PURGE AND TRAP METHOD FOR ACID VOLATILE SULFIDE (AVS) ANALYSIS

A2.1 Scope

This method is applicable to sediments having up to 300 mmol/kg (dry weight) of AVS. The detection limit is approximately 0.01 mmol/kg when using the methylene blue colorimetric method for determining sulfide concentrations. Because sulfide is unstable in the presence of oxygen, it is necessary to protect samples from exposure to air. It is recommended that samples are frozen immediately after collection and all subsequent manipulations are carried out in a nitrogen atmosphere.

A2.2 Materials

AVS evolution and H₂S trapping

The apparatus and procedure is based on the method recommended by the USEPA (Allen et al., 1991, 1992). The apparatus consists of a 250 mL round bottom flask with a sidearm and two 15 mL impingers with non-fritted inlets. Sediment is weighed into the round bottom flask and acid is introduced via the side arm. The apparatus is connected via a flow controller to a nitrogen line that purges the evolved hydrogen sulfide from the reaction flask to the traps.

The following modifications have been made to the method described by Allen et al.:

- (i) The volume of H₂S trapping solution (0.5 M NaOH) has been reduced from 80 mL to 10 mL without any deterioration in system performance.
- (ii) The nitrogen flow rate 20 mL/min used by Allen et al. (1993) was found to give unacceptably low recoveries, suggesting that flow rate may be system dependent. The nitrogen flow rate has been re-optimised at 250 to 300 mL per minute which has given around 100% recovery from tests conducted using estuarine sediments of 150 mmol/kg AVS.
- (iii) Tests have indicated that standard high purity 'cylinder' nitrogen gives acceptable performance.

Instrumentation and apparatus

- A visible spectrophotometer – capable of measuring absorbance at 670 nm.
- An ICPAES for the determination of SEM.
- Magnetic stirrer and Teflon coated stirring bars.
- Glove box and argon purged fish tank for sample handling and manipulation.
- Drying oven.
- Top loading balance capable of weighing 0.01g.
- General laboratory glassware.

A2.3 Reagents

All water and reagents must be free of dissolved oxygen and sulfides. Only Milli-Q water that has been purged by nitrogen for at least 3 h should be used.

H₂S trapping solution, 0.5 M NaOH

Dissolve 20 g sodium hydroxide (NaOH) in 1 L of deoxygenated Milli-Q water. Prepare daily.

Methylene blue reagent (MBR)

Component A – Add 660 mL concentrated sulfuric acid to 340 mL of deoxygenated Milli-Q water. After the solution cools, add 2.5 g N-N-dimethyl-p-phenylenediamine oxalate (store in a freezer) and mix until dissolved. (Note: replace N-N-dimethyl-p-phenylenediamine oxalate every 6 months.)

Component B – Dissolve 5.4 g ferric chloride hexahydrate (FeCl₃.6H₂O) in 100 mL

concentrated hydrochloric acid and dilute to 200 mL with Milli-Q water.

Prepare the MBR by mixing components A and B.

This reagent should be stored in an amber glass bottle. It is stable for at least one month.

Hydrochloric acid, 6.0 M

Dilute 500 mL of concentrated hydrochloric acid (analytical reagent grade or better) to 1 L with Milli-Q water. This solution is deaerated as required by bubbling deoxygenated nitrogen through for at least 30 minutes before use. If ICPAES blanks are unacceptable, a better grade of acid should be used.

Sulfuric acid, 1.0 N

Dilute 28 mL concentrated sulfuric acid (H_2SO_4) to 1 L with Milli-Q water.

Starch Indicator

Dissolve 1.0 g soluble starch in 100 mL boiling water.

Standard sodium thiosulfate solution, 0.025 N

Dilute the contents of a 0.1N Volucon to 500 mL as specified in the instructions. Transfer 250 mL of this solution to a 1 L volumetric flask and make up to 1 L with deionised water.

Standard iodine solution 0.025 M (0.050 N) {or 0.05 M (0.10 N)}

Dilute the contents of an iodine Volucon (BDH) to make 1000 mL of 0.025 M or 0.05 M standard iodine solution.

Sulfide stock solution, ~50 mM

Weigh out ~5 g of $\text{Na}_2\text{S}\cdot 9\text{H}_2\text{O}$ (Sigma, ACS), rinse quickly (to remove adsorbed impurities) and dissolve it in 500 mL of deoxygenated Milli-Q water. Store this concentrated sulfide stock solution in the nitrogen-filled glove box.

Calculate the sulfide concentration from Equation 1. The sulfide stock solution should be restandardised every 2 weeks. The sulfide stock solution has a storage life of up to 6 months if kept in the nitrogen-filled glove box.

Standardisation of sulfide stock solution

Pipette 10.0 mL of 0.05 N (or 5.0 mL of 0.10 N) of the standard iodine solution into each of two 125 mL Erlenmeyer flasks.

Pipette 2.0 mL of the sulfide stock solution into one flask and 2.0 mL of Milli-Q water into the other flask as a reagent blank.

Add 5.0 mL of 6 M HCl into each flask. Swirl slightly then cover with Parafilm and place in the dark for 5 minutes.

Titrate each with the standard thiosulfate solution, adding soluble starch indicator when the yellow iodine colour fades. The end point is reached when the blue colour disappears.

The solution should be restandardised every week.

A2.4 AVS Distillation Procedure

- Place the frozen sample in a nitrogen-filled glove box and allow to thaw overnight.
- Pre-weigh the stoppered reaction flask on a top pan balance (with magnetic flea).
- Add 100 mL of deoxygenated Milli-Q water (using a measuring cylinder) to the reaction flask.
- Using a clean 25 mL syringe, measure 10 mL 0.5 M NaOH trapping solution into each of two H_2S trapping tubes. Fit the tubes in position and secure with rubber bands.
- Fit the reaction flask to the AVS system and bubble with nitrogen for 2 minutes at 280 mL/min (or a flow rate of 2-3 bubbles per second) – make sure the

flow rate is not so high that the 0.5 M NaOH trapping solution is displaced from the tubes.

- Homogenise the analysis sample in the nitrogen-filled glove box by mixing with a plastic-coated spatula.
- Transfer about ~25 g of wet sample to a preweighed 30 mL polycarbonate vial. Record the weight and retain for dry weight determination (110°C, see below).
- Transfer between 1-2 g of wet sediment to a strip of Parafilm on a tared top pan balance. If the sample has a high water content, transfer to a small plastic weighing tray. Record the wet weight of the sample. Large masses of calcareous samples should be avoided as this will cause excessive frothing.
- Transfer the weighed sample *with the minimum of delay* to the reaction flask. The Parafilm may be inserted through the side arm or a liquid sample washed into the flask via the sidearm with a minimum quantity of oxygen-free Milli-Q water.
- Purge for 2 minutes at 280 mL/min.
- Turn off the nitrogen flow (at the flowmeter), and using a clean plastic disposable syringe add 20 mL of 6 N hydrochloric acid through the sidearm $920 \text{ mL} \times 6 \text{ M HCl} / (100 \text{ mL} + 20 \text{ mL}) = 1 \text{ M HCl}$.
- Start the magnetic stirrer and adjust the speed to enable moderate stirring of the sample.
- Bubble nitrogen through the sample for 30 minutes at 280 mL/min.
- Quantitatively transfer the contents of both H₂S trapping tubes to a 50 mL volumetric flask (use a funnel to avoid spillage). The contents of the traps should be washed into the flask with 0.5 M NaOH solution. Make up to 50 mL with 0.5 M NaOH, stopper and shake thoroughly.
- Stopper the main reaction flask containing the acid-leached sample and retain the contents for SEM

determination. Weigh as described in A2.6 (below).

A2.5 Sulfide Determination

Calibration standards

A working sulfide standard (~2 mM) should be prepared by diluting 2 mL of the sulfide stock solution into a 50 mL volumetric flask and making it up to volume with deoxygenated 0.5 M NaOH (made in deoxygenated Milli-Q).

This standard should be prepared on a daily basis and stored refrigerated (or in the nitrogen-filled glove box).

Pipette 0, 50, 100, 200, 300, 500 µL of the working sulfide standard (~2 mM) into a series of 30 mL polycarbonate vials containing 10 mL 0.5 M NaOH. The resulting standards have the following approximate concentrations in the range: 0-0.2 mM. The exact concentrations of the standards should be calculated from the standardisation data. Standards should be prepared on a daily basis.

Sulfide analyses of standards and samples

General Method

Add 1 mL of methylene blue reagent (MBR) reagent per 10 mL of sample (or standard) and allow it to sit for 90 min for the methylene blue colour development.

Following colour development (90 min), pipette 1 mL of the sample (or standard) into a 30 mL polycarbonate vial containing 9 mL 1 M H₂SO₄.

Analyse at 670 nm using a UV-VIS spectrophotometer.

Samples

An initial guess of the AVS content of the sample is advisable. Always, for precautionary measures, dilute samples at least 1 mL/10 mL with 0.5 M NaOH (10-fold dilution). However, it is often necessary (for very smelly sediments) to dilute 50-100-fold (0.1-0.5 mL/10 mL).

If the blue colour of the resulting solution is more intense than that of the 4th standard (1.5), then a further dilution of the sample with 0.5 M NaOH is required before adding the MBR. A 10-fold dilution is achieved by taking 5 mL of the original solution and making up to 50 mL with 0.5 M NaOH. A 100-fold dilution is achieved by taking 0.5 mL of the original solution and making up to 50 mL with 0.5 M NaOH

For the samples, it is ideal if they give final absorbance of <0.3 since this is the most linear part of the calibration curve. If absorbance is >0.35, then it is advisable that samples are re-analysed after further dilution. (Note. Dilutions must be made before addition of MBR, not after its reaction has taken place.)

UV-VIS Spectrometer

Set the wavelength to 670 nm. The instrument must be in absorbance mode. Zero the instrument on two blank solutions.

A2.6 Simultaneously Extractable Metals (SEM)

Place the stoppered reaction flask on a tared top pan balance and make up to 140 mL final volume. Shake the flask and transfer ~110 mL to a labelled 120 mL polycarbonate vial and allow to settle. After settling (3-4 h), decant of the liquid (avoiding shaking) into a labelled 30 mL polycarbonate vial for ICPAES analysis (Simultaneous Extracted Metals, SEM).

Analyse the solution for Cu, Zn, Cd, Pb, Ni, Fe, Mn, by ICPAES.

A2.7 Dry Weight Determination

Place the 30 mL vial containing wet sediment in a drying oven (110°C) overnight. Transfer to a dessicator and allow to cool to room temperature. Re-weigh the vial including the dried sediment sample. Calculate the dry weight/wet weight ratio (DW/WW) by gravimetric analysis.

Use the dry-weight/wet-weight ratio to calculate the dry weight of sediment used in the AVS measurement.

A2.8 Quality Control

A blank and spike-recovery sample should be run every day. The blank comprises 100 mL of deoxygenated Milli-Q water and a piece of Parafilm or plastic dish.

The recovery is carried out on a sub-sample of sediment analysed in the same batch. Add a known weight of sediment to the reaction flask (as described above) followed by a known volume of sulfide standard (ideally $\sim 2 \times$ AVS-content of the sample). Carry out the AVS analysis as described in the method and calculate the amount of sulfide recovered from this addition.

Sulfide spikes

For a sample with low AVS (e.g. one which is to be diluted 10-fold), a suitable spike would be 5.0 mL of the working sulfide standard.

For a sample with high AVS (e.g. 100-200 mmol/kg – one which is to be diluted 100-fold), a suitable spike would be 4.0 mL of the sulfide stock solution.

A2.9 References

- Allen, H.E., Fu, G., and Deng, B. (1992). Analysis of acid volatile sulfide (AVS) and simultaneously extracted metals (SEM) for the estimation of potential toxicity in aqueous sediments. *Environ. Toxicol. Chem.*, 12, 1441-1453.
- Allen, H.E., Fu, G., Boothman, W., Di Toro, D.M., and Mahoney, J.D. (1993). Determination of acid volatile sulfide and selected simultaneously extractable metals in sediment. U.S. Environmental Protection Agency, Office of Water Regulations and Standards, Criteria and Standards Division, Washington, D.C.
- Simpson, S. L. (2001). A rapid screening method for acid-volatile sulfide in sediments. *Environ. Toxicol. Chem.*, 20, 2657-2661.
- Simpson, S.L., Apte, S.C., and Batley, G.E. (1998). Effect of short-term resuspension events on trace metal speciation in polluted anoxic sediments. *Environ. Sci. Technol.*, 32, 620-625.

APPENDIX 3. RAPID METHOD FOR ACID VOLATILE SULFIDE (AVS) ANALYSIS

A3.1 Scope

The method is applicable to sediments having AVS concentrations in the range 0.5 to 300 mmol/kg (sediment, dry weight) (Simpson, 2001). The limit of determination is approximately 0.5 mmol/kg. The method utilises the direct reaction of 'Clines reagent' (methylene blue) (Cline, 1969) with small amounts of sediment followed by colorimetric determination of AVS and offers fast analysis times without the need for specialised glassware or equipment. A comparison between AVS measured by this method and that measured using a purge-and-trap AVS method shows a linear relationship, although the method underestimates the AVS concentration measured by the purge-and-trap method. Because sulfide is unstable in the presence of oxygen it is necessary to protect samples from exposure to air. It is recommended that samples are frozen immediately after collection and all subsequent manipulations are carried out in a nitrogen or argon atmosphere (glove box or bag).

A3.2 Materials

- Centrifuge capable of 2500 rpm and housing 50 mL polycarbonate centrifuge tubes.
- Glove box for sample handling, desired but not mandatory.
- Drying oven (110°C).
- Analytical balance capable of measuring to ± 3 mg (i.e. to 0.001 g).
- Spectrophotometer to measure at 670 nm (single or double beam).
- Laboratory film (Parafilm M).

A3.3 Reagents

As for the Purge and Trap Method (Appendix 2).

A3.4 AVS Procedure

- Place the frozen sediment sample in a nitrogen gas-filled glove box to thaw.
- Homogenise the analysis sample in the glove box by mixing with a Teflon spatula.
- Tier a small square (1.5 cm \times 2 cm) of laboratory film (e.g. Parafilm M) on an analytical balance (accuracy ± 0.001 g).
- Carefully transfer the weighed square of laboratory film to the glove box, smear a small sample of sediment (0.02-0.10 g dry weight) onto the surface, then accurately weigh (± 3 mg) and immediately transfer to a 50 mL centrifuge tube (in glove box if possible).
- Repeat in triplicate for each sample.
- To each centrifuge tube add 50 mL of deoxygenated Milli-Q water (volumetrically) from a wash bottle in the glove box. *Attention: Try not to disturb the sediment on the Parafilm too much.*
- Pipette 5 mL of methylene blue reagent (MBR) into each water-filled tube (using a calibrated 5 mL pipette), then cap the tube and invert it five times to mix. *Caution: Methylene blue reagent (MBR) is toxic.*
- After 5 min, centrifuge at 2500 rpm for 2 min.
- Allow to sit for 90 min for the methylene blue colour development.

Attention: During this period, take care not to significantly disturb the sediment (i.e. no further shaking) because the MBR reagent adsorbs to sediment particles.

A3.5 Sulfide Determination

Sulfide standards

A working sulfide standard (~ 2 mM) should be prepared by diluting a 50 mM sulfide stock solution into a 50 mL volumetric flask and making it up to volume with deoxygenated 0.5 M NaOH (made in deoxygenated Milli-Q water).

This standard should be prepared on a daily basis and stored refrigerated (or in the nitrogen gas-filled glove box).

Pipette 0, 50, 100, 200, 300, 500 μ L of working sulfide standard into a series of 30 mL polycarbonate vials containing 10 mL 0.5 M NaOH. The resulting standards have concentrations in the range 0-0.2 mM. The exact concentrations of the standards should be calculated from the standardisation data. *Standards should be prepared on a daily basis.*

Sulfide analyses of standards and samples

Add 1 mL of MBR reagent per 10 mL of sample (or standard) and allow it to sit in the dark for 90 min for the methylene blue colour development.

Following colour development, dilution is required. Pipette 1 mL of the sample (or standard) into a 30 mL polycarbonate vial containing 9 mL 1 M H_2SO_4 .

Measure the solution absorbance at 670 nm using a UV-VIS spectrophotometer.

If the absorbance of the sample is of greater than that of the standard with the highest sulfide concentration then the sample should be reanalysed using a smaller amount of sediment (per unit volume). This is in preference to further dilution of the sample.

A3.6 References

- Cline, J.D. (1969). Spectrophotometric determination of hydrogen sulfide in natural waters. *Limnol. Oceanogr.*, 14, 454-458.
- Simpson, S. L. (2001). A rapid screening method for acid-volatile sulfide in sediments. *Environ. Toxicol. Chem.*, 20, 2657-2661.

APPENDIX 4. PROTOCOL FOR WHOLE-SEDIMENT TOXICITY TESTS USING THE MARINE MICROALGA *ENTOMONEIS* CF. *PUNCTULATA*

(Prepared by Merrin Adams, Centre for Environmental Contaminants Research, CSIRO Energy Technology, Lucas Heights, NSW 2234)

A4.1 Scope and Application

This guide describes methods for testing the short-term adverse effects of potentially contaminated sediment on the marine unicellular microalga *Entomoneis* cf. *punctulata* during static 3- or 24-h exposures. This method is based on the protocol of Adams and Stauber (2004) and is applicable to sediments and pore waters containing most chemicals, either individually or as mixtures.

A4.2 Method Summary

This toxicity test determines the acute toxicity of estuarine or marine test sediments to algae. The test is a cell viability bioassay that determines the inhibition of enzyme (esterase) activity in the benthic alga *Entomoneis* cf. *punctulata* after a 3- or 24-h exposure to whole sediment (1 g sediment plus 9 mL overlying water) or pore water (10 mL) compared to sediment or seawater-only controls.

Esterase activity is measured by flow cytometry after incubation with the substrate fluorescein diacetate (FDA). Healthy cells take up the lipophilic FDA stain. Intracellular esterases cleave the diacetate ester bonds yielding fluorescein, a hydrophilic anion that is retained by intact viable cells that then fluoresce in the green region of the spectrum when excited by blue light. Toxicants reduce the uptake of FDA and cleavage by the enzyme. This is measured by flow cytometry as a decrease in intracellular FDA fluorescence intensity, seen as a shift in the number of algal cells outside the control region and the percentage shift out of the control region is calculated. The enzyme (esterase) activity test

can be used to assess both waters (pore waters/surface waters) and whole-sediments.

A4.3 Significance and Use

Micro-organisms play an important role in nutrient cycling and degrading organic matter in sediments. Even though benthic micro-organisms do not ingest sediment particles, they are in intimate contact with sediments and this has been shown to enhance sediment toxicity to bacteria. Benthic algae (microphytobenthos) play an important role in stabilising sediments, providing habitat, modulating chemical transformations and remobilising metals at the sediment-water interface. Benthic algae are a common food source for invertebrates (e.g. amphipods) and hence have the potential for trophic transfer of contaminants from sediments to higher trophic levels.

Short duration tests that detect acute sub-lethal endpoints, such as inhibition of enzyme activity, show promise for overcoming some of the limitations of standard algal growth tests. Enzyme inhibition, rather than inhibition of algal growth, has been found to be a more suitable endpoint for algal whole-sediment tests because toxic effects are not masked by stimulation from ammonia release from the sediments. Inhibition of esterase activity in algae has been shown to relate well to metabolic activity and cell viability (Gala and Giesy, 1990). Esterases are a group of enzymes involved in phospholipid turnover in cell membranes and can be measured *in vivo* using fluorogenic stains such as fluorescein diacetate (FDA). FDA is a lipophilic non-fluorescent dye that diffuses freely across the plasma membrane. Esterases hydrolyse FDA in the cytoplasm, producing fluorescein, which is retained by viable cells. Fluorescein fluorescence can be detected by flow cytometry and reflects both esterase activity

and cell membrane integrity, both of which indicate cell viability (Dorsey et al., 1989; Franklin et al., 2001).

Flow cytometry is a rapid method for the measurement of the light scattering and fluorescence properties of cells in a moving fluid. Microalgae are ideal for flow cytometric analysis because they are single-celled organisms containing photosynthetic pigments, such as chlorophyll a, which autofluoresce when excited by blue light (488 nm) and can therefore be easily distinguishable from sediment particles. Two light scatter detectors provide information on the morphology of the cell. The forward angle light scatter (FSC, <math><15^\circ</math>) detector provides information on cell size, while the side angle light scatter (SSC,

In this protocol, the use of a BD-FACSCalibur (Becton Dickinson BioScience, San Jose, CA, USA) flow cytometer to measure algal esterase activity is described. It should be noted that between different flow cytometers the instrument settings and methods of analysis may vary. The flow cytometry toxicity tests described here require considerable investment in equipment and skilled operators. However, once the individual test protocols are established, it is relatively easy to train operators in their routine use.

A4.4 Test Organism

The unicellular benthic marine alga *Entomoneis* sp. (strain no. CS-426) was obtained from CSIRO Marine Research, Hobart (Tasmania, Australia). *Entomoneis* sp. was originally isolated from Little Swanport ($42^\circ 20' : 147^\circ 56'$), on the east coast of Tasmania by Richard Knuckey in 1995. The isolate was identified as *Entomoneis* cf. *punctulata* Osada

et Kobayashi (CS-426) by Dr Gustaff Hallegraeff (University of Tasmania, Australia).

Culturing of algae

Algae are cultured in a modified half-strength f-medium (Guillard and Ryther, 1962) with the iron and trace element concentrations halved (Table A2). Cultures are maintained in 50 mL of sterilised (autoclaved) f-medium in 250 mL sterilised Schott bottles. Each week 1 mL of 1-week old algae is transferred under axenic conditions to fresh media prepared 1-3 d in advance. Cultures are maintained on a 12 h light:12 h dark cycle (Philips TL 40 W fluorescent daylight, $60 \mu\text{mol}/\text{m}^2/\text{s}$) at 21°C .

Preparation of algae for toxicity testing

Cells in exponential growth (5 days old) are used in the algal bioassays after washing three times with filtered seawater to remove algal culture medium (centrifuged at 700 g for 7 min each wash). Algal cells are inoculated into the test vials immediately after the cells have been washed.

A4.5 Equipment Summary

- Flow cytometer (e.g. FACSCalibur, Beckman Dickinson or equivalent).
- Constant temperature chamber or temperature controlled room with 12 h light (1-3 and $60 \mu\text{mol photons}/\text{s}/\text{m}^2$), 12 h dark cycle, maintained at $21 \pm 1^\circ\text{C}$.
- Test vials: 20-mL glass scintillation vials or 30-mL polycarbonate vials.
- Culture flasks: 250 mL Schott bottles or flasks with glass lids.
- Diluent/Control seawater (filtered to $0.45 \mu\text{m}$).
- Dissolved oxygen, pH, salinity and conductivity meters.
- Top pan balance (0.01 g) and analytical balance.

A4.6 Procedures

A4.6.1 Test materials

Control seawater

Seawater used for culturing algae, in QA controls and as overlying water in toxicity tests, is collected from an uncontaminated site and filtered through a 0.45 µm filter on the day of collection. The salinity of filtered seawater is approximately 35‰. Seawater is stored at 4°C and equilibrated to room temperature prior to use.

Control sediment

Sediments with varying grain size distributions (fine and coarse sediments) used as controls in toxicity tests were collected from uncontaminated sites (e.g. Bonnet Bay in the Woronora River, south of Sydney and Grays Point in the Port Hacking River, south of Sydney). In each test, the grain size of the control sediment is matched as closely as possible to the grain size of the test sediment. Additional control sediments of similar grain size to the test sediment can be prepared by mixing an appropriate weight of two sediments (fine and coarse) together. Control sediment is collected using a stainless steel spade or hand trowel and is press sieved through a 1.1 mm stainless steel mesh sieve on site to remove large pieces of organic matter and organisms. Sieved sediment is collected in plastic bags and placed in Eskies with ice or cooler blocks and returned to the laboratory and stored at 4°C for a maximum of 2 months. Sediment is placed at room temperature prior to being used to allow it to acclimate to the test and culture temperature. As algal enzyme activity in test sediments is compared to algal enzyme activity in control sediments in the toxicity test, it is crucial that the control sediment not only has low contaminant levels but must also have similar physico-chemical properties to the test sediment including grain size and porewater salinity.

Test sediment

Test sediments should be collected and stored in containers made of inert materials to

prevent contamination. Sediments should be chilled when collected and, shipped on ice and stored in the dark in a refrigerator at 4°C. They should not be frozen or allowed to dry out and should be used in tests as soon as possible and within 8 weeks of receipt. Prior to use, test sediments are placed at room temperature to allow them to acclimate to the test temperature. The particle size distribution of the sediments should be carried out prior to testing to aid the selection of a suitable control sediment for use in the toxicity test.

Porewater extraction

Pore water is extracted from sediments immediately prior to testing (on the initial day of the test). Homogenised sediment (200-400 g) is transferred into 250 mL plastic (low density polyethylene) centrifuge bottles and centrifuged for 10 min at 3000 rpm. The extracted pore water is then filtered through an acid-washed 0.45 µm membrane filter. To ensure that no contaminants are introduced into the sample during the porewater extraction procedure, a method blank consisting of seawater that has been passed through the same centrifugation and filtration procedure should be included in the toxicity test. The salinity, conductivity, pH and dissolved oxygen should be measured on all porewater samples prior to testing to ensure that the physico-chemical parameters of the sample are within the test limits.

A4.7 Whole-sediment Toxicity Test

A4.7.1 Test setup

A summary of the test protocol is shown in Table A2. Sediments are tested in quadruplicate at one test concentration (10% w/v), together with a control sediment of a similar grain size. Sediment test vials are prepared by weighing 1 g of wet sediment into a glass scintillation vial (or a 30-mL polycarbonate vial) and gently dispensing 9 mL of seawater to minimise sediment disturbance. Two vials are prepared for each replicate, one vial for 3-h analysis and one vial for 24-h analysis. An additional replicate is prepared

Table A2. Culture medium (f-medium) for *Entomoneis cf. punctulata*

Stock Solution No.	Nutrient	Stock Solution	Volume per 50 mL seawater (mL)
1 ^b	NaNO ₃	7.5 g / 100 mL	0.100
2 ^b	Na ₂ SiO ₃ .5H ₂ O	6.25 g / 250 mL	0.050
3 ^b	C ₆ H ₅ O ₇ Fe.5H ₂ O	0.45 g	0.050
	Citric acid	0.45 g / 100 mL	
4 ^b	Metals		
	CoCl ₂ .6H ₂ O	10 mg	
	CuSO ₄ .5H ₂ O	9 mg	
	Na ₂ SiO ₃ .5H ₂ O	7 mg	
	MnCl ₂ .4H ₂ O	180 mg	
	ZnSO ₄ .7H ₂ O	22 mg / L	0.050
5 ^b	Vitamins ^a		
	C ₆₃ H ₈₈ N ₁₄ PCo	0.025 g / 250 mL	
	Cyanocobalamin (B ₁₂)		
	C ₁₀ H ₁₆ N ₂ O ₃ S	0.05 g / 500mL	
	Biotin (H)		
	C ₁₂ H ₁₇ N ₄ OSCl.HCl		0.050
	Thiamine (B ₁ .HCl)		
6 ^b	Na ₂ MoO ₄ .2H ₂ O	12.6 mg / L	0.050
7 ^b	NaH ₂ PO ₄ .2H ₂ O	2.5 g / 250 mL	0.050

^aAdd 2.5 mL of vitamin B12 stock and 2.5 mL of biotin to a 250 mL volumetric flask containing 0.05 g thiamine. Make up to volume with Milli-Q water.

^bStock solution No. 7 is sterilised independently of the fmedium and added immediately prior to transferring algae.

for pH measurements throughout the test. Each vial is carefully inoculated just above the sediment surface with $5-9 \times 10^4$ cells/mL of a pre-washed algal suspension. Samples are incubated at 21°C on a 12-h light:12-h dark cycle at $1 \mu\text{mol photons/s/m}^2$ without disturbance for 3 or 24 h.

A4.7.2 Analysis of algal esterase activity

After a 3- or 24-h exposure, each vial is shaken briefly to resuspend the algae and left for 30 s to allow large sediment particles to settle. A 5-mL sub-sample of the supernatant is homogenised in a hand-held tissue grinder. FDA (125 μL of 1 mM stock in acetone prepared daily) is added to a 4.88 mL homogenised sub-sample and incubated for 5 min. Immediately prior to analysis, a small fraction is filtered through a Microtox[®] solid-phase filter column (~50 μm pore size, pre-rinsed with seawater) to remove any remaining large sediment

particles that could potentially block the flow cytometer aperture. Samples are analysed for esterase activity (measured as FDA fluorescence) with excitation at 488 nm and the resulting fluorescence collected in detector FL1 (i.e. green fluorescence) using a FACSCalibur flow cytometer (Beckman Dickinson). The instrument flow rate is set on high (approximately 60 $\mu\text{L}/\text{min}$). Sediment particles and unhealthy cells are excluded from the analysis by setting a threshold on chlorophyll *a* fluorescence (>650 nm), just to the left of the algal population. The algal population is identified using a plot of chlorophyll fluorescence (FL3) versus side scatter (SSC). The FDA (FL1) fluorescence of the algal cells only is plotted using a histogram of FDA (FL1) fluorescence versus cell count. The region S2 is manually defined around the FDA fluorescence intensity of the sediment control. The percentage of cells falling into regions S1 (decreased FDA fluorescence), S2 (normal FDA fluorescence) and S3 (enhanced

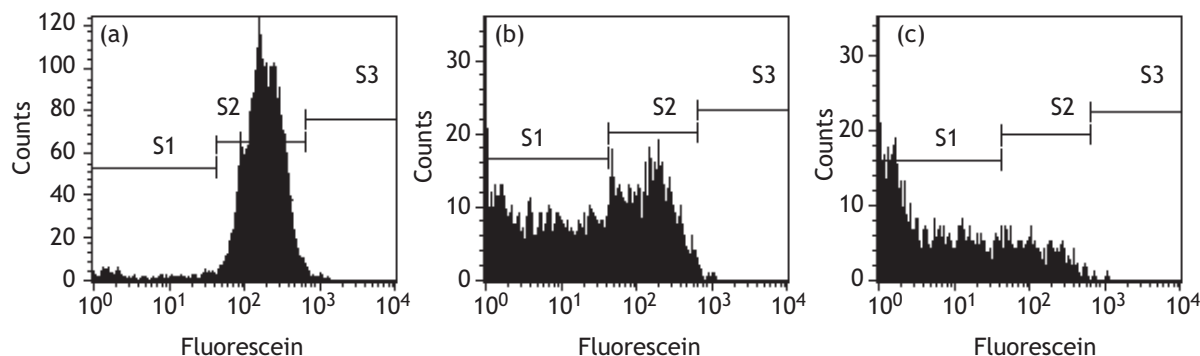

Figure A1. Flow cytometric histogram showing shifts in esterase activity (FL1 fluorescence versus cell count) of *E. cf. punctulata* after a 24-h exposure to copper: (a) 0 µg/L, 4% in S1; (b) 85 µg/L, 58% in S1; (c) 250 µg/L, 78% in S1

Table A3. Summary of Toxicity Test Conditions for the *Entomoneis cf. punctulata* Esterase Inhibition Test (Whole Sediment)

Test type	Static
Temperature	21±2 °C
Light quality	'Daylight' fluorescent lighting
Light intensity	1 µmol photons/s/m ²
Photoperiod	12 h light/12 h dark
Test chamber size	20 mL
Test solution volume	10% w/v
Renewal of test solutions	None
Age of test organisms	5 d
Growth phase	Exponential
Initial cell density	5-9 x 10 ⁴ cells/mL
No. replicate chambers / sample	4
Dilution water	Seawater filtered to 0.45 µm
PH range	6.5-8.5
Salinity	15-35‰
Test duration	3 h and 24 h
Effect measured	Enzyme (esterase) inhibition
Test acceptability	>15% healthy FDA fluorescence for seawater controls, >80% healthy FDA fluorescence in sediment controls, Reference toxicant within Cusum limit

FDA fluorescence) are recorded and expressed as a percentage decrease in S2/S3 compared to sediment controls (Figure A1). The pH of each sample is measured at the end of the test (i.e. after a 3- and 24-h exposure).

A4.8 Porewater Toxicity Test

A4.8.1 Test setup

Porewater toxicity tests with the alga *E. cf. punctulata* follow a similar protocol to that

outlined for testing whole sediments, as summarised in Table A3.

Pore waters are tested at either one concentration only (100%) in quadruplicate, or using a series of concentrations prepared by pipetting the appropriate volumes of pore water and filtered seawater directly into 20-mL glass scintillation vials. A total volume of 10 mL of each porewater solution, is prepared in each test vial. Due to the limited volume of pore water generally extracted from

sediments, one vial per replicate is prepared and sub-sampled at 3- and 24-h for analysis of esterase activity. Each vial is inoculated with algae ($2\text{-}4 \times 10^4$ cells/mL) and incubated under the standard conditions.

Analysis of algal esterase activity

After a 3- and 24-h exposure, each vial is shaken and a sub-sample (2.44 mL) transferred to a clean glass vial. After incubation with FDA (63 μL of a 1 mM FDA solution in acetone, prepared daily) for 5 min, algal esterase activity is measured by flow cytometry using a high flow rate (60 $\mu\text{L}/\text{min}$). Unhealthy cells are excluded from the analysis by setting a threshold on chlorophyll *a* fluorescence (FL3, >650 nm), just to the left of the algal population. The algal population is identified using a plot of chlorophyll fluorescence (FL3) versus side scatter (SSC). The FDA (FL1) fluorescence of the algal cells only is plotted using a histogram of FDA (FL1) fluorescence versus cell count. The region S2 is manually defined around the FDA fluorescence intensity of the seawater control. The percentage of cells falling into regions S1 (decreased FDA fluorescence), S2 (normal FDA fluorescence) and S3 (enhanced FDA fluorescence) are recorded and expressed as a percentage decrease in S2/S3 compared to seawater controls (Figure A1). The pH of each sample is measured at the end of the test (i.e. after a 3- and 24-h exposure).

A4.9 Statistical Procedures

Each replicate is expressed as a percentage decrease in S2/S3 (healthy FDA fluorescence intensity) compared to sediment or seawater controls according to the following equation:

$$\frac{100 - \%S1_t}{100 - \%S1_c} \times 100 \quad (1)$$

where $\%S1_t$ is the percentage of treated cells in S1, and $\%S1_c$ is the average percentage of control (untreated cells) in S1.

A sediment sample is defined as toxic if there is more than a 20% inhibition in enzyme activity compared to the control sediment

(i.e. <80% of the control), and, is significantly different to the control sediment ($p \leq 0.05$). This criterion is based on test variability during the test development period and is in agreement with published protocols for amphipod acute toxicity tests using whole sediment (Environment Canada, 1997).

The proportional data is arc sine transformed and tested for normality of distribution (Shapiro-Wilk's test) and homogeneity of variance (Bartlett's test) prior to hypothesis testing. If the assumptions of normality and homogeneity are met, the Dunnett's Test can be used and Steel's test can be used if the assumptions are not met. These t-tests determine if the response of the algae in the test sample is different to that in the control.

For toxicity tests where a concentration-response relationship is observed, multiple treatments are compared to a single control to determine no observable effect concentration (NOEC) and lowest observable effect concentrations (LOEC). The Trimmed Spearman-Kärber method is then used to determine the EC50 value (the concentration of test sample to cause a 50% inhibition in esterase activity).

A4.10 Quality Assurance

Controls

Seawater controls are included in each toxicity test (10 mL of seawater only, in triplicate) to determine the intensity of FDA fluorescence associated with healthy (untreated) esterase activity in algal cells. Seawater controls are analysed following the procedure outlined in Section 4.5.

One additional seawater control replicate is prepared and inoculated with algae for use as a positive control (dead cells killed by formalin). When the test is initiated (t_0), 0.4 mL of formalin is added to the vial (i.e. 4% formalin) to kill the algae and the vial is then stored at 4°C. At 3 and 24 h, subsample 2.44 mL and incubate with 63 μL of a 1 mM FDA solution (in acetone, prepared daily) for 5 minutes and measure the algal esterase activity following the procedure outlined in

Table A4. Summary of Toxicity Test Conditions for the *Entomoneis cf. punctulata* Esterase Inhibition Test (Porewater Test)

Test type	Static
Temperature	21±2 °C
Light quality	'Daylight' fluorescent lighting
Light intensity	1 µmol photons/s/m ²
Photoperiod	12 h light/12 h dark
Test chamber size	20 mL
Test solution volume	10 mL
Renewal of test solutions	None
Age of test organisms	5 d
Growth phase	Exponential
Initial cell density	2-4 x 10 ⁴ cells/mL
No. replicate chambers / sample	4
Dilution water	Seawater filtered to 0.45 µm
pH range	6.5-8.5
Salinity	15-35‰
Test duration	3 h and 24 h
Effect measured	Enzyme (esterase) inhibition
Test acceptability	>15% healthy FDA fluorescence for seawater controls; Reference toxicant within Cusum limit

Section 4.5. The FDA fluorescence intensity of the positive control (dead cells) and unstained (no FDA) seawater controls must be significantly less (not overlap by more than 10%) than the fluorescence intensity measured in the seawater controls.

Reference toxicant

A reference toxicant is run in parallel with each toxicity test and the EC50 values calculated. The reference toxicant, copper, is recommended to assess the relative sensitivity of the algae used in the toxicity test and the precision and reliability of the data produced under standardised test conditions in the laboratory. A water-only exposure is recommended for reference toxicants and is carried out by following the porewater testing protocol described in Section 3.5. Copper, added as copper (II) sulfate, is added to seawater to give concentrations of 25, 50, 100 and 300 µg Cu/L, in duplicate. Prepare two extra vials per test concentration, one for physico-chemistry and one for chemical analysis of the reference toxicant. Samples for copper analysis are filtered through an acid-washed 0.45 µm membrane syringe filter and acidified to 2% nitric acid (Normatom) for

analysis by ICPAES. A definitive test consisting of at least 5 concentrations, in quadruplicate, should be carried out monthly and a cumulative summation chart prepared using the EC50 values. Two standard deviations around the average EC50 value define the acceptable EC50 limits.

Criteria for test acceptability

The use of negative controls (untreated algal cells with healthy esterase activity) and positive controls (dead cells with inactivated esterase activity) defines the expected FL1 fluorescence intensity for the no effect test concentrations and 100% effect (inhibition) in esterase activity respectively. A separation with <10% overlap in FL1 fluorescence intensity is required to ensure that shifts in FL1 fluorescence can be quantified. Control FDA-stained cells should display a normal distribution for the algal population on the FL1 histogram. The control region, S2, can then be confidently defined around >90% of the cells.

The reference toxicant copper should be within 2SDs of the cumulative summation chart of EC50 values.

A4.11 References

- Adams, M.S., and Stauber, J.L. (2004). Development of a whole-sediment toxicity test using a benthic marine microalga. *Environ. Toxicol. Chem.*, 23, 1957-1968.
- Dorsey, J., Yentsch, C., Mayo, S., and McKenna, C. (1989). Rapid analytical technique for the assessment of cell metabolic activity in marine microalgae. *Cytometry*, 10, 622-628.
- Environment Canada (1997). Biological Test Method: Test for survival and growth in sediment using the freshwater amphipod *Hyalella azteca*. Environment Canada Report EPS 1/RM/33, Ottawa, ON, Canada.
- Franklin, N.M., Adams, M.S., Stauber, J.L., and Lim, R.P. (2001). Development of an improved rapid enzyme inhibition bioassay with marine and freshwater microalgae using flow cytometry. *Arch. Environ. Contam. Toxicol.*, 40, 469-480.
- Gala, W.R., and Giesy, J.P. (1990). Flow cytometric techniques to assess toxicity to algae. In: *Aquatic Toxicology and Risk Assessment*, Vol. 13, Landis, W.G., and Van der Schalie, W.H., (editors), American Society for Testing and Materials, Philadelphia, USA, pp. 237-246.
- Guillard, R.R.L., and Ryther, J.H. (1962). Studies of marine planktonic diatoms. I. *Cyclotella nana* and *Detonula confervaceae* Hustedt (cleve) Gran. *Can. J. Microbiol.*, 8, 229-239.

APPENDIX 5. PROTOCOL FOR WHOLE-SEDIMENT ACUTE AMPHIPOD TOXICITY TESTS USING *MELITA PLUMULOSA*

(Prepared by Catherine King, Centre for Environmental Contaminants Research, CSIRO Energy Technology, Lucas Heights, NSW 2234)

A5.1 Scope and Application

This guide describes methods for testing the short-term adverse effects of potentially contaminated sediment on juveniles or adults of the estuarine amphipod *Melita plumulosa* during static 10-day exposures. This protocol is adapted from USEPA (1994a,b), ASTM (1998) and Environment Canada (1998) methods with some modifications for local environmental conditions and for use with the local species. It is applicable to sediments containing most chemicals, either individually or in mixtures. Modifications of these procedures might be appropriate for other test organisms and other sediment toxicity test procedures including an *in-situ* test.

A5.2 Methods Summary

This toxicity test determines the acute toxicity of estuarine or marine test sediments to amphipods following a 10-day exposure. The test may be conducted on juveniles (<7 d old) or on adults (2-3 months old). Each test consists of control sediment and one or more test sediments. For each sediment, a total of 4-5 replicate beakers are used, each containing 20 amphipods. In the adult test, 200 g of sediment with overlying water to 900 mL are added to a 1 L beaker. For the juvenile test, 80 g of sediment and overlying water to 360 mL are added to a 400 mL beaker. The response of amphipods to the test sediment is compared with their response to control (reference) sediment after 10 days. The standard end point is % survival of amphipods exposed to the test sediment relative to the controls. Additional end points that may be used include post-exposure recovery (juvenile

and adult tests), growth (juvenile test) and accumulation of contaminants (adult test).

A5.3 Significance and Use

Amphipods are an abundant and important component of the soft bottom estuarine and marine benthic community. Many epibenthic species including *Melita plumulosa* directly ingest sediment particles and are therefore directly exposed to sediment-bound contaminants. They are a principal prey item of many birds, fish and larger invertebrates and hence have the potential for trophic transfer of contaminants from sediments to higher trophic levels. The ecological importance of amphipods, their wide distribution and high abundance, the ease of handling and ability to be cultured in the laboratory, and their sensitivity to contaminated sediments make them appropriate species for sediment toxicity testing.

The test procedure describes a rapid, standard toxicity test that provides an indication of the potential toxicity of estuarine and marine sediment samples to local biota. Such an acute test is not intended to exactly simulate the exposure of benthic amphipods under 'natural' conditions but is conducted to obtain information on the immediate effects of a short-term exposure to test sediment under specific environmental conditions. The test described can also provide information about whether delayed effects will occur if the post-exposure recovery period is included. Another additional end point, accumulation of contaminants in the body tissues of exposed amphipods, is useful in determining the biological availability of contaminants and the likely routes of exposure and uptake of contaminants by the amphipod.

A5.4 Test Organism

Collection, handling and culturing of amphipods

Amphipods used in tests are obtained from laboratory-maintained cultures. Stock cultures are originally established from animals collected from intertidal mud flats at Brooklyn in the Hawkesbury River, north of Sydney. Amphipods are collected at low tide from the top few mm of sediment or from the undersurface of rocks and shell grit. They are placed into clean, plastic containers with water and a thin layer of sediment, collected *in-situ*. Containers with amphipods are transported back to the laboratory in Eskies maintained at ambient temperature or lower. Amphipods are kept in a temperature-controlled laboratory at 21±2°C in clean plastic holding trays (40×30×10 cm) containing 1.1 mm sieved sediment to a depth of 1-2 cm and approximately 5 cm of overlying water (0.45 µm filtered seawater (FSW)) at a salinity of 30‰. A maximum of 300 adults may be kept per tray without overcrowding or any reduction in reproduction and growth. Overlying water in trays is continuously gently aerated and trays are covered with foil to minimise light disturbances to the amphipods.

During culturing, amphipods are fed the diatom *Phaeodactylum tricornutum* (1×10⁵ cells/animal) and Sera micron fry food enhanced with vitamins (0.5 mg/amphipod), twice weekly. The overlying water in holding trays is renewed weekly (by gentle siphoning) and sediment is changed every 4-6 weeks. At the sediment changes, amphipods are sieved from sediments and sorted into age/size classes before being put into separate holding trays with fresh sediment and water. This ensures that amphipods of a uniform and known size and age are used for the toxicity tests.

Prior to the start of the test, amphipods are slowly acclimated to the test salinity as required (if test salinity is different from 30‰), by increasing or decreasing the salinity of the overlying water in aquaria by 1-2‰ per day. At least three quarters of the water is removed and replaced with FSW at the appropriate salinity (prepared by the addition

of Milli-Q water to natural FSW at 35.5‰) each day. Amphipods are fed (as above) after every water change. Animals are isolated from the holding sediment by gentle sieving through 500 µm sieves immediately prior to test commencement.

A5.5 Equipment Summary

- Constant temperature chamber or temperature controlled room with 12 h light (3.5 µmol photons/s/m²), 12 h dark cycle, maintained at 21 ± 1°C
- Test chambers: 1 L (adult test) or 400 mL (juvenile test) glass beakers
- Air supply and tubing
- Diluent/Control FSW (0.45 µm)
- DO, pH and salinity/conductivity meters
- Stainless steel sieves: 500 µm mesh (adult test) or 260 µm mesh (juvenile test)
- Plastic weigh boats
- Plastic pipette (wide bore)
- Stainless steel spade or hand trowel to collect control sediment
- Esky with ice or cooler blocks

A5.6 Procedures

Test materials

Control sediment

Sediment used for culturing amphipods and as the control sediment in toxicity tests is collected from the original site of amphipod collection or from an uncontaminated area with sediment that has properties within the geochemical requirements of the species (e.g. Bonnet Bay in the Woronora River, south of Sydney. This sediment consists of 95% fine particles (<63 µm) and has a porewater salinity of 30‰ and a pH of 7.2). Control sediment is collected using a stainless steel spade or hand trowel and is press sieved through a 1.1 mm stainless steel mesh sieve on site to remove large pieces of organic matter and organisms. Sieved sediment is collected in plastic bags

and placed in eskies with ice or cooler blocks and returned to the laboratory and stored at 4°C for a maximum of 2 months. Sediment is placed at room temperature (21±2°C) for a minimum of 24 h prior to being used to allow it to acclimate to the test and culturing temperature. As survival in test sediments is compared to survival in control sediments in the toxicity test, it is crucial that the control sediment not only has low contaminant levels but must also have similar physico-chemical parameters to the test sediment including grain size and porewater salinity.

Control seawater

Seawater used for culturing, acclimating amphipods and as overlying water in toxicity tests is collected from an uncontaminated site (e.g. entrance to Port Hacking, Fisheries Research Institute, Cronulla, NSW) and is filtered to 0.45 µm. The salinity of FSW is approximately 35.5‰ and is adjusted to a lower salinity (as required) by the addition of Milli-Q water.

Test sediment

Test sediments should be collected and stored in containers made of inert materials to prevent contamination. Sediment should be chilled when collected, shipped on ice and stored in the dark in a refrigerator at to 4°C. It should not be frozen or allowed to dry out and should be used in tests as soon as possible and within 8 weeks of receipt. Prior to its use, test sediment is placed at room temperature (21±2°C) for a minimum of 24 h to allow it to acclimate to the test temperature.

A5.7 Toxicity Test

Test setup

A summary of the test protocol is shown in Table A5. On the day before the test is started, each test sediment sample and the control sediment is homogenised within its storage container. Pore water that has separated from the samples during storage should be mixed back into the sediment using a nontoxic device, such as a stainless steel spoon or

Teflon spatula. A 200 g or 80 g aliquot of each of the sediments to be tested is added to four replicate 1 L or 400 mL glass beakers for the adult and juvenile test respectively. The sediment is smoothed out and air pockets removed by gently tapping the beaker against the side of the hand to settle the contents. Overlying FSW (30‰ or at the required salinity) is then added to each beaker to give a total volume of 900 mL for the adult test or 360 mL for the juvenile test. FSW is added by gentle and slow pouring down the side of the beaker to minimise mixing and re-suspension of the sediment. If monitoring of sediment chemistry is required, an additional beaker should be set up. Beakers are capped with Perspex covers and placed into a constant temperature chamber or room at 21±1°C overnight to equilibrate and to allow suspended particles to settle. The overlying water in each beaker is continuously gently aerated via glass pipette tips to maintain dissolved oxygen conditions.

Test initiation – addition of amphipods

On the following day, overlying water from each of the test beakers is removed by gentle siphoning and is replaced by fresh FSW at the required salinity. Following water renewals, the test commences when a total of 20 amphipods (juveniles or adults) are randomly assigned and added to each beaker. Adults of a uniform size and age (8-10 mm; 2-3 months) are sieved (500 µm) from stock cultures immediately prior to being added to test beakers at the start of the test. For the juvenile test, an appropriate number of gravid females are separated from stock cultures and placed in small holding trays (16×12×2 cm) with a thin layer of sediment (<1 mm deep) 7 d before the toxicity test is due to commence. Gravid females will drop their brood of 3-6 juveniles within the week, providing juveniles <7 d old for the start of the test. Juveniles are sieved from gravid female holding trays immediately prior to being added to test beakers at the start of the test. Amphipods are distributed using a wide bore plastic pipette to plastic weight boats prior to their addition to beakers to confirm the number and health (assessed by swimming behaviour) of all individuals added. Amphipods that are sluggish

Table A5. Summary of Test Conditions for the 10-d Acute Sediment Toxicity Test with the Amphipod *Melita plumulosa*

Test type	Static non-renewal	
Test duration	10 d	
Temperature	21 ± 1°C	
Salinity	30 ± 1‰ (or as required)	
pH	7.2 - 8.2	
Ammonia	< 1 mg/L	
Light intensity	3.5 µmol photons/s/m ²	
Photoperiod	12 h light/12 h dark	
Aeration	1 outlet with slow bubbling to maintain ≥85% dissolved oxygen saturation in overlying water throughout the test	
Test chamber	Adult test	Juvenile test
	1 L glass beaker	450 mL glass beaker
Sediment weight	200 g	80 g
Overlying water volume	~ 700 mL	~ 280 mL
Total test volume	900 mL	360 mL
Age/size of test organisms	2-3 months / 8-10 mm length	< 7 d
No. test organisms/ test chamber	20	
No. replicate chambers/ sample	4 (minimum); 5 th replicate for chemical analysis sampling if required	
Feeding	None during test	
Overlying water renewal	None during test (static)	
Control sediment	Uncontaminated sediment with similar physico-chemical parameters (grain size, pore water salinity and pH) to the test sediment	
Overlying water	Uncontaminated seawater collected from a clean site, filtered to 0.45 µm and diluted with Milli-Q water to 30 ± 1‰ or to the required salinity	
Sediment sample weight required	2 kg (minimum 1 kg)	
Reference toxicant	Copper; Water only exposure, duration = 96 h; Whole sediment exposure, duration = 10 d	
Standard endpoint	Survival	
Alternative endpoints	Post-exposure recovery in FSW Contaminant tissue concentrations (Adult test only) Growth in body length (Juvenile test only)	
Test acceptability criteria	≥75% survival in controls, physico-chemical parameters (dissolved oxygen, pH, salinity and temperature) within acceptable limits throughout the test, reference toxicant test results within specified limits	

or appear or behave atypically when sieved from the sediment are discarded. Care must be taken when adding amphipods to test beakers to ensure that all organisms enter the overlying water. This is especially important for the juveniles, as they are particularly susceptible to getting trapped on the water surface. Once the amphipods have been added, the beakers are randomly positioned in the constant temperature chamber or room at

21±1°C. Beakers are capped with Perspex covers and overlying water is continuously and gently aerated by slow bubbling for the test duration via glass pipette tips suspended 4 cm below the water surface to maintain ≥85% dissolved oxygen saturation without causing disturbance to the surface of the sediment. Lighting is on a 12-h light (3.5 µmol photons/s/m²), 12-h dark cycle throughout the test.

Test maintenance and termination

On each day throughout the test, beakers are checked to ensure that aeration is maintained and evaporation is minimal. Dead animals and moulted exoskeletons are removed from the beakers and scored where possible. Observations to assess amphipod behaviour and location are also made daily if required. Amphipods caught in the surface film of the beaker should be pushed down into the water using a glass rod or pipette. Physico-chemical measurements can also be done periodically in 1 beaker for each treatment (Section 3.5). After 10 days, the test is terminated. The contents of each beaker are wet sieved through a 500 µm (adult test) or 260 µm (juvenile test) stainless steel mesh using FSW to retain amphipods. Most of the overlying water is decanted through the sieve. The remaining water is swirled to suspend the top layer of sediment and this is decanted through the sieve. The majority of the amphipods should be in this top layer of the sediment. The remaining sediment is washed in stages through the sieve until all amphipods are accounted for or until all the sediment has been inspected. Material retained on the screen is washed into a sorting tray using control FSW. All amphipods are collected using a wide bore plastic pipette and placed in culture water for counting and to verify they are alive. The number of amphipods that are alive in each beaker is recorded, and the results expressed as % survival. Animals that are missing are presumed to have died and disintegrated and are counted as dead.

Chemical and physico-chemical analyses

An additional replicate beaker per treatment should be set up to monitor chemical and physico-chemical parameters at the start of the test, throughout the test and at test termination. Physico-chemical parameters in the overlying water, including dissolved oxygen, pH, ammonia, salinity and temperature, are monitored to ensure that they remain within acceptable limits for quality control purposes. Sub-samples of the overlying water, before renewal on Day 0 of the test and at test termination on Day 10, may be taken from this beaker for ammonia

analysis and other chemical analysis. Whole-sediment and porewater (0.45 µm filtered) samples may also be taken from this beaker at test termination for toxicant analysis. For metal-contaminated sediments, total particulate metal (TPM) concentrations, acid-soluble metal concentrations (by dilute HNO₃ digestion) and SEM/AVS in whole sediments may be measured in addition to porewater metal concentrations at the start and termination of tests. Overlying water and porewater samples for metals analysis are acidified with concentrated nitric acid (HNO₃) to a concentration of 2% and stored at 4°C until analysed.

Statistical analysis

Results of toxicity tests are reported in terms of the % survival in test sediments relative to survival in the control sediment. This proportional data is arc sine transformed and tested for normality of distribution (Shapiro-Wilk's test) and for homogeneity of variance (Bartlett's test) prior to hypothesis testing. Dunnett's Test (parametric) is then used if assumptions of normality and homogeneity of variances are met, and Steel's test (non-parametric) is used when variances are heterogeneous and the distribution unequal. For toxicity tests on single test sediment samples, these t-tests determine if the response of the amphipods in the test sediment is different to that in the control sediment. For toxicity tests in which a concentration series of spiked sediments or a dilution series of highly toxic sediment is tested, multiple treatments are compared with a single control to determine no observed effect concentration (NOEC) and the lowest observed effect concentration (LOEC). Maximum Likelihood Regression using Probit Analysis with Abbott's correction or Non-Linear Interpolation with Bootstrapping (lcp) if assumptions of the Probit Analysis are not met, are also used to determine LC50 values and 95% confidence limits. Significance in all statistical tests is set at the $p < 0.05$ level and all statistical analyses are carried out using the software Toxcalc for Microsoft Excel (Version 5.0.23, TidePool Scientific Software, California, 1994) or some other appropriate software.

A5.8 Additional Toxicity Test Endpoints

Post-exposure recovery

For the adult and juvenile tests, the ability for amphipods to recover following exposure to contaminated sediments may be determined in a short test following the termination of the standard 10 d survival test. Surviving amphipods once scored are placed into clean beakers containing 900 mL (adult tests) or 360 mL (juvenile tests) of fresh FSW (at the same salinity as that used in the test) and small strips of nylon mesh to provide a surface for amphipods to settle on. Beakers are capped and returned to the constant temperature chamber or room at $21\pm 1^\circ\text{C}$ with constant gentle aeration to the water. Beakers are left overnight and at 24 h, the number of surviving amphipods in each beaker is again recorded, and the results expressed as % survival.

Accumulation of contaminants in the body tissues

For the adult test, the concentration of contaminants in the body tissues of amphipod may be determined following the termination of the standard 10-d survival test. Methods are as for the post exposure recovery test, with amphipods left in beakers containing fresh FSW overnight to allow gut passage clearance and the removal of sediment particles from body surfaces. This ensures that only assimilated contaminants will be measured in the analysis of body tissues.

After the 24-h depuration period, surviving amphipods are blotted dry on filter paper to remove excess water. They are then added in groups of 4-5 amphipods to pre-weighed 5 mL polycarbonate vials. The wet weight (WW) of each group of amphipods is determined using an analytical balance (Sartorius 1601) accurate to 0.05 mg. Vials are then placed in a clean oven at 60°C for a minimum of 24 h. After cooling at room temperature in a desiccator, each vial is re-weighed and the dry weight (DW) of the amphipods is calculated. Ultrapure HNO_3 (Trace Pur Merck, 0.25 mL/50 mg DW) is added to each vial and vials are left at room temperature in a fume cupboard for 24 h to

digest. Vials are then heated in a domestic microwave oven for 20 min (1100 W; 10% power). After cooling at room temperature, H_2O_2 is added to each vial (0.25 mL/ 50 mg DW), and vials are left for 24 h to further digest. Vials are again microwaved (as above) and allowed to cool to room temperature. Samples are then diluted with Milli-Q water to a final volume of 5 mL/ 50 mg DW. Metal concentrations are measured by ICP-AES. For quality control purposes, one blank (Milli-Q water) and two reference samples (TORT-2, National Research Council Canada) are included with the amphipod samples.

Growth

For the juvenile test, the growth of amphipods in terms of their body length may be used as a sublethal endpoint following the termination of the standard 10-d survival test. Surviving amphipods are fixed in formalin and then transferred to 5 mL polycarbonate vials containing 10% ethanol where they are stored prior to being measured using image analysis.

A5.9 Quality Control

Test acceptability

Test conditions and physico-chemical parameters (dissolved oxygen, pH, ammonia, salinity and temperature) must remain within acceptable limits throughout the test.

The control sediment provides a measure of the acceptability of the test by providing evidence of the health and quality of the test organisms and the suitability of the test conditions, overlying water and handling procedures etc. An average amphipod survival rate of 75% or greater in the control sediment indicates test acceptability.

A concurrent reference toxicant test should also be performed to assess the relative sensitivity of the amphipods used for the toxicity test, and the precision and reliability of data produced under standardised test conditions by the laboratory. Either a 96-h test in FSW using a range of concentrations or, more preferably, a 10-d sediment test using

control sediment spiked with a range of toxicant concentrations can be used. The endpoint (e.g. LC50) of that test must fall within the control limits established for the test. The control limits are based on a minimum of 10 previous replicate tests and are set at $\pm 2SD$ from the mean response using appropriate software. If the results fall outside these limits, the test should be repeated. The reference toxicant test should be initiated at the same time as the assay with the test sediment.

A5.10 Reference Toxicant Test

Copper is recommended as the reference toxicant for *M. plumulosa* in either water-only exposure test of 96 h duration, or in a 10-d whole-sediment exposure. All conditions for tests are the same as for the standard test described above, except a minimum of 3 replicates are required for each test concentration, a minimum of 15 amphipods are added per beaker, and for water only tests, no sediment is added to the test beakers. Concentrations tested must bracket the predicted LC50 from previous tests and data obtained from reference toxicant tests is added to a cumulative chart in which the acceptable range for LC50 values are calculated (mean $\pm 2 SD$).

Water-only reference toxicant test

A water-only reference toxicant test is recommended over the whole-sediment reference toxicant test due to the greater ease and reduced time spent in preparing and conducting the test, and to the greater consistency in the response of amphipods observed in replicate tests. For water-only tests, sediment is not added to beakers and a piece of 500 μm mesh is placed on the base of each beaker to provide a surface for amphipods to hold onto. Control FSW is spiked with copper (as copper salt). Nominal total copper concentrations recommended for

juveniles are 20, 40, 80, 160, 320 $\mu\text{g/L}$ and for adults are 50, 100, 200, 300 and 400 $\mu\text{g/L}$.

Whole-sediment reference toxicant test

Control sediment is spiked with copper salt at a range of concentrations. The dry/wet ratio (moisture content) of the sediment is determined by placing a small amount of wet sediment in a vial, recording the wet weight, drying the sediment at 60°C for 4 h or until dry and then reweighing to obtain the dry weight. The ratio is then used to determine the amount of metal salt to be added (per gram dry weight of sediment) to the original wet sediment. Nominal total copper concentrations for tests with juveniles and adults are 400, 800, 1200, 1600 and 500, 1000, 1500, 2000, 2500 mg/kg DW sediment respectively.

All spiking procedures including manipulations of spike solutions and spiked sediments (except for rolling and re-hydrating) are done within a nitrogen-filled glove box (Section 3.4.4; Simpson et al., 2004).

A5.11 References

- ASTM (1998). Standard guide for conducting 10-day static sediment toxicity tests with marine and estuarine amphipods, E 1367-99, American Society of Testing and Materials, Philadelphia, PA, USA.
- Environment Canada (1998). Biological Test Method: Reference method for determining acute lethality of sediments to marine or estuarine amphipods. Method Development and Application Section, Environmental Technology Centre, Environment Canada Environmental Protection Series, EPS 1/RM/35, Ottawa, ON, Canada.
- USEPA (1994a). Methods for assessing the toxicity of sediment-associated contaminants with estuarine and marine amphipods. Office of Research and Development, U.S. Environmental Protection Agency Report EPA/600/R-94/025, Duluth, MN, USA.
- USEPA (1994b). Methods of measuring the toxicity and bioaccumulation of sediment-associated contaminants with freshwater invertebrates. Office of Research and Development, U.S. Environmental Protection Agency Report EPA/600/R-94/024, Duluth, MN, USA.

APPENDIX 6. PROTOCOL FOR WHOLE-SEDIMENT ACUTE BIVALVE TOXICITY TESTS USING *TELLINA DELTOIDALIS*

(Prepared by Catherine King, Centre for Environmental Contaminants Research, CSIRO Energy Technology, Lucas Heights, NSW 2234)

A6.1 Scope and Application

This guide describes methods for testing the short-term adverse effects of potentially contaminated sediment on young adults of the estuarine bivalve *Tellina deltoidalis* during static 10-d exposures. This protocol is adapted from USEPA (1994, 2000) and ASTM (1999) methods with some modifications for local environmental conditions and for use with the local bivalve species. It is applicable to sediments containing most chemicals, either individually or in mixtures. Modifications of these procedures might be appropriate for other test organisms and other sediment toxicity test procedures including *in situ* tests.

A6.2 Methods Summary

This toxicity test determines the acute toxicity of estuarine or marine test sediments to bivalves following a 10-d exposure. The test is conducted on young adults (5-10 mm in length). Each test consists of control sediment and one or more test sediments. For each sediment, a total of 4-5 replicate beakers are used, each containing 15-20 bivalves. In the test, 200 g of sediment with overlying water to 900 mL is added to a 1 L beaker. The response of bivalves to the test sediment is compared with their response to control (reference) sediment after 10 d. The standard end point is % survival of bivalves exposed to the test sediment relative to the controls. Additional end points that may be used include post-exposure recovery, post-exposure reburial and accumulation of contaminants in the bivalve's soft body tissues and/or shell.

A6.3 Significance and Use

Bivalves are an abundant and important component of the soft-bottom estuarine and marine benthic community. Many infaunal species including *Tellina deltoidalis* feed on suspended particulate matter in the water column (filter feeding) as well as directly ingesting sediment particles (deposit feeding). They are therefore potentially exposed to both aqueous and sediment-bound contaminants. Bivalves are a principal prey item of many birds, fish and larger invertebrates and many species accumulate high levels of contaminants in their tissues. They therefore have the potential for trophic transfer of contaminants from sediments and waters to higher trophic levels. The ecological importance of bivalves, their wide distribution and high abundance, their ease of handling and their relative sensitivity to contaminated sediments make them appropriate species for sediment toxicity testing.

The test procedure describes a rapid, standard toxicity test that provides an indication of the potential toxicity of estuarine and marine sediment samples to local biota. Such an acute test is not intended to exactly simulate the exposure of benthic bivalves under 'natural' conditions but is conducted to obtain information on the immediate effects of a short-term exposure to test sediment under specific environmental conditions. The test described can also provide information about whether delayed effects will occur if the post-exposure recovery period or reburial test is included. Another additional end point, accumulation of contaminants in the body tissues of exposed bivalves, is useful in determining the biological availability of contaminants and the likely routes of exposure and uptake of contaminants by the bivalve.

A6.4 Equipment Summary

- Constant temperature chamber or temperature controlled room with 12 h light ($3.5 \mu\text{mol photons/s/m}^2$), 12 h dark cycle, maintained at $21 \pm 1^\circ\text{C}$
- Test chambers: 1 L glass beakers
- Diluent/Control filtered seawater (FSW; $0.45 \mu\text{m}$)
- DO, pH and salinity/conductivity meters
- Stainless steel sieve with 1.1 mm mesh
- Plastic containers ($16 \times 12 \times 4 \text{ cm}$) for field collections
- Plastic holding trays ($40 \times 30 \times 10 \text{ cm}$) for laboratory holding
- stainless steel spade or hand trowel to collect control sediment
- Esky with ice or cooler blocks

A6.5 Procedures

Test materials

Control sediment

Control sediment used in toxicity tests is collected from the site of bivalve collection or from an uncontaminated area with sediment that has properties within the geochemical requirements of the species. Control sediment is collected using a stainless steel spade or hand trowel and is press-sieved through a 1.1 mm stainless steel mesh sieve on site to remove large pieces of organic matter and organisms. Sieved sediment is collected in plastic bags and placed in an esky with ice or cooler blocks and returned to the laboratory and stored at 4°C for a maximum of 2 months. Sediment is placed at room temperature ($21 \pm 2^\circ\text{C}$) for a minimum of 24 h prior to being used to allow it to acclimate to the test and culturing temperature. As survival in test sediments is compared to survival in control sediments in the toxicity test, it is crucial that the control sediment not only have low contaminant levels but must also have similar physico-chemical parameters to the test sediment including grain size and porewater salinity.

Control seawater

Seawater used for acclimating bivalves and as overlying water in toxicity tests is collected from an uncontaminated site (e.g. entrance to Port Hacking River, Fisheries Research Institute, Cronulla, NSW) and is filtered to $0.45 \mu\text{m}$. The salinity of filtered seawater (FSW) is approximately 35.5‰ and is adjusted to a lower salinity (as required) by the addition of Milli-Q water.

Test sediment

Test sediments should be collected and stored in containers made of inert materials to prevent contamination. Sediment should be chilled when collected, shipped on ice and stored in the dark in a refrigerator at to 4°C . It should not be frozen or allowed to dry out and should be used in tests as soon as possible and within 8 weeks of receipt. Prior to its use, test sediment is placed at room temperature ($21 \pm 2^\circ\text{C}$) for a minimum of 24 h to allow it to acclimate to the test temperature.

Collection and handling of bivalves

Bivalves used in tests are obtained from field populations collected from estuarine sand and mud flats around Sydney. Bivalves are collected at low tide from the top 10 cm of sediment using a shovel and a 1 mm mesh stainless steel sieve. Young adults of a uniform size and age (5-10 mm in length) only are collected. They are placed into clean, plastic containers ($16 \times 12 \times 4 \text{ cm}$) with water and a 3 cm thick layer of sediment, collected *in situ*. Containers with bivalves are transported back to the laboratory in an esky maintained at ambient temperature or lower. Bivalves are kept in a temperature-controlled laboratory at $21 \pm 2^\circ\text{C}$ in clean plastic holding trays ($40 \times 30 \times 10 \text{ cm}$) containing 1.1 mm sieved sediment to a depth of 3 cm and approximately 5 cm of overlying water ($0.45 \mu\text{m}$ FSW) at a salinity of 30‰. A maximum of 150 bivalves may be kept per tray without overcrowding. Overlying water in trays is continuously gently aerated and trays are covered with foil to minimise light disturbances to the bivalves.

Bivalves are held in the laboratory for a minimum of 2 d and a maximum of 1 week prior to being used in tests. If required (i.e. test salinity is different from 30‰), bivalves are slowly acclimated to the test salinity over this period, by increasing or decreasing the salinity of the overlying water in aquaria by 1-2 ‰ per d. At least three quarters of the water is removed and replaced with FSW at the appropriate salinity (prepared by the addition of Milli-Q water to natural FSW at 35.5‰) each day. Animals are isolated from the holding sediment by gentle sieving through 1.1 mm sieves immediately prior to test commencement.

A6.6 Toxicity Test

Test setup

A summary of the test protocol is shown in Table A6. On the day before the test is started, each test sediment sample is homogenised within its storage container. A 200 g aliquot of each of the sediments to be tested is added to four replicate 1 L glass beakers. The sediment is smoothed and air pockets removed by gently tapping the beaker against the side of the hand to settle the contents. Overlying FSW (30‰ or at the required salinity) is then added to each beaker to give a total volume of 900 mL. FSW is added by gentle and slow pouring down the side of the beaker to minimise mixing and re-suspension of the sediment. Beakers are capped with Perspex covers and placed into a constant temperature chamber or room at $21\pm 1^\circ\text{C}$ overnight to allow suspended particles to settle and equilibrium to be established between the sediment and overlying water. The overlying water in each beaker is continuously gently aerated to maintain dissolved oxygen conditions. If monitoring of sediment chemistry is required, additional beakers with sediment and bivalves should be set up.

Test initiation - addition of bivalves

On the following day, overlying water from each of the test beakers is removed by gentle siphoning and replaced by fresh FSW at the required. Following water renewals, the test

commences when a total of 15 to 20 bivalves are randomly assigned and added to each beaker. Bivalves are sieved from holding trays immediately prior to being added to test beakers at the start of the test. Once the bivalves have been added, the beakers are again covered and randomly positioned in the constant temperature chamber or room at $21\pm 1^\circ\text{C}$ with constant gentle aeration to the overlying water.

Test maintenance and termination

On each day throughout the test, beakers are checked to ensure that there is adequate aeration and dead animals and shells are removed from the beakers and scored where possible. Observations to assess bivalve behaviour and location are also made daily if required. After 10 days the test is terminated. The contents of each beaker are sieved through a 1.1 mm stainless steel mesh to retain bivalves. All bivalves are collected using Teflon tweezers and placed in FSW in small plastic trays (16×12×2 cm) for counting and to verify they are alive. The number of surviving bivalves in each beaker is recorded, and the results expressed as % survival.

Chemical and physico-chemical analyses

An additional replicate beaker per treatment should be set up to monitor chemical and physico-chemical parameters at the start of the test, throughout the test and at test termination. Physico-chemical parameters in the overlying water including dissolved oxygen, pH, salinity and temperature are monitored to ensure that they remain within acceptable limits for quality control purposes. Sub-samples of the overlying water before renewal on Day 0 of the test, and at test termination on Day 10, may be taken from this beaker for ammonia analysis and other chemical analysis. Whole-sediment and porewater (0.45 µm filtered) samples may also be taken from this beaker at test termination for toxicant analysis. For metal-contaminated sediments, total particulate metal (TPM) concentrations, acid-soluble metal concentrations (by weak HNO_3 digestion) and SEM/AVS in whole sediments may be measured in addition to

Table A6. Summary of Test Conditions for the 10-d Acute Sediment Toxicity Test with the Bivalve *Tellina deltoidalis*

Test type	Static non-renewal
Test duration	10 d
Temperature	21 ± 1°C
Salinity	30 ± 1‰ (or as required)
pH	7.8 - 8.2
Light intensity	3.5 µmol photons/s/m ²
Photoperiod	12 h light/12 h dark
Aeration	1 outlet with slow bubbling to maintain ≥85% dissolved oxygen saturation in overlying water throughout the test
Test chamber	1 L glass beaker
Sediment weight	200 g
Overlying water volume	700 mL
Total test volume	900 mL
Size of test organisms	5-10 mm length
No. of test organisms / test chamber	15-20
No. of replicate chambers / sample	4 (minimum); 5th replicate for chemical analysis sampling if required
Feeding regime	None during the test
Overlying water renewal	None during the test (static)
Control sediment	Uncontaminated sediment with similar physico-chemical parameters (grain size, pore water salinity and pH) to the test sediment
Overlying water	Uncontaminated seawater collected from a clean site, filtered to 0.45 µm and diluted with Milli-Q water to 30 ± 1 ‰ or to the required salinity
Reference toxicant	Copper; Water only exposure, duration = 96 h; Whole sediment exposure, duration = 10 d
Standard endpoint	Survival
Alternative endpoints	Post-exposure recovery in FSW Post-exposure reburial in control sediment Contaminant tissue concentrations
Test acceptability criteria	≥75% survival in controls, physico-chemical parameters (dissolved oxygen, pH, salinity and temperature) within acceptable limits throughout the test

porewater metal concentrations at the start and termination of tests. Overlying water and porewater samples for metals analysis are acidified with concentrated nitric acid (HNO₃) to a concentration of 2% and stored at 4°C until analysed.

Statistical analysis

Results of toxicity tests are reported in terms of the % survival in test sediments relative to survival in the control sediment. This proportional data is arc sine transformed and tested for normality of distribution (Shapiro-Wilk's test) and for homogeneity of variance

(Bartlett's test) prior to hypothesis testing. Dunnett's Test (parametric) is then used if assumptions of normality and homogeneity of variances are met, and Steel's test (non-parametric) is used when variances are heterogeneous and the distribution unequal. For toxicity tests on single test sediment samples, these t-tests determine if the response of the amphipods in the test sediment is different to that in the control sediment. For toxicity tests in which a concentration series of spiked sediments or a dilution series of highly toxic sediment is tested, multiple treatments are compared with a single control to determine no observed

effect concentration (NOEC) and the lowest observed effect concentration (LOEC). Maximum Likelihood Regression using Probit Analysis with Abbott's correction or Non-Linear Interpolation with Bootstrapping (lcp) if assumptions of the Probit Analysis are not met, are also used to determine LC50 values and 95% confidence limits. Significance in all statistical tests is set at the $p < 0.05$ level and all statistical analyses are carried out using the software Toxcalc for Microsoft Excel (Version 5.0.23, TidePool Scientific Software, California, 1994) or some other appropriate software.

A6.7 Additional Toxicity Test Endpoints

Post exposure recovery

The ability for bivalves to recover following exposure to contaminated sediments may be determined in a short test following the termination of the standard 10-d survival test. Surviving bivalves, once scored, are placed into clean beakers containing 900 mL of fresh FSW (at the same salinity as that used in the test). Beakers are capped and returned to the constant temperature chamber or room at $21 \pm 1^\circ\text{C}$ with constant gentle aeration to the water. Beakers are left overnight and at 24 h, the number of surviving bivalves in each beaker is again recorded, and the results expressed as % survival.

Post exposure reburial

The ability for bivalves to rebury in control sediment following exposure to contaminated sediments may be determined in a short test following the termination of the standard 10 d survival test. Surviving bivalves once scored are placed into clean 1 L beakers containing 200 g of control sediment and overlying fresh FSW to 900 mL of (at the same salinity as that used in the test). Beakers are capped and returned to the constant temperature chamber or room at $21 \pm 1^\circ\text{C}$ with constant gentle aeration to the overlying water. Beakers are left for 2 h and the number of bivalves that have buried fully into the sediment in each beaker is recorded, and the results expressed as % reburial relative to the number of

surviving bivalves initially placed in the beakers. Effective mortality is then calculated as the sum of dead bivalves plus those that fail to rebury in clean control sediment.

Accumulation of contaminants in the body tissues

The concentration of contaminants in the body tissues of bivalves may be determined following the termination of the standard 10-d survival test. Methods are as for the post-exposure recovery test, with bivalves left in beakers containing fresh FSW overnight to allow gut passage clearance and the removal of sediment particles trapped within the shells of bivalves. This ensures that only assimilated contaminants will be measured in the analysis of body tissues.

After the 24-h depuration period, surviving bivalves are dissected to separate the shell from the soft body tissue. Accumulation in the soft tissue component is usually done but the shell may also be analysed. Soft tissues from single bivalves are then added to pre-weighed 5 mL polycarbonate vials. The wet weight (WW) of each soft tissue is determined using an analytical balance (Sartorius 1601) accurate to 0.05 mg. Vials are then placed in a clean oven at 60°C for a minimum of 24 h. After cooling at room temperature in a desiccator, each vial is re-weighed and the dry weight (DW) of the bivalve soft tissue is calculated. Ultrapure HNO_3 (Trace Pur Merck, 0.25 mL/ 50 mg DW) is added to each vial and vials are left at room temperature in a fume cupboard for 24 h to digest. Vials are then heated in a domestic microwave oven for 20 min (1100 W; 10% power). After cooling at room temperature, H_2O_2 is added to each vial (0.25 mL/ 50 mg DW), and vials are left for 24 h to further digest. Vials are again microwaved (as above) and allowed to cool to room temperature. Samples are then diluted with Milli-Q water to a final volume of 5 mL/ 50 mg DW. Metal concentrations are measured by ICPAES. For quality control purposes, one blank (Milli-Q water) and two reference samples (TORT-2, National Research Council Canada) are included with the amphipod samples.

A6.8 Quality Control

Test acceptability

Test conditions and physico-chemical parameters (dissolved oxygen, pH, salinity and temperature) must remain within acceptable limits throughout the test.

The control sediment provides a measure of the acceptability of the test by providing evidence of the health and quality of the test organisms and the suitability of the test conditions, overlying water and handling procedures etc. An average bivalve survival rate of 75% or greater in the control sediment indicates test acceptability.

A concurrent reference toxicant test should be also be performed to assess the relative sensitivity of the population of bivalves used for the toxicity test, and the precision and reliability of data produced by the laboratory. Either a 96-h test in seawater using a range of concentrations or more preferably, a 10-d sediment test using control sediment spiked with a range of concentrations can be used. The endpoint (eg LC50) of that test must fall within the control limits established for the test. The control limits are based on a minimum of 10 previous replicate tests and are set at $\pm 2SD$ from the mean response using appropriate software. If the results fall outside these limits, the test should be repeated. The reference toxicant test should be initiated at

the same time as the assay with the test sediment.

A6.9 Reference Toxicant Test

Copper or cadmium is recommended as the reference toxicant for *T. deltoidalis* in either a water-only exposure test of 96 h duration, or in a 10-d whole-sediment exposure. All conditions for tests are the same as for the standard test described above, except only 2-3 replicates are required for each test concentration and only 10-15 bivalves are added per beaker. Concentrations tested must bracket the predicted LC50 from previous test and knowledge.

A6.10 References

- ASTM (1999). Standard guide for conducting 10-day static sediment toxicity tests with marine and estuarine amphipods, E 1367-99. American Society for Testing Materials, Philadelphia, PA, USA.
- USEPA (1994). Methods for assessing the toxicity of sediment-associated contaminants with estuarine and marine amphipods. Office of Science and Technology, U.S. Environmental Protection Agency Report EPA 600/R-94/025, Narragansett, Rhode Island, USA.
- USEPA (2000). Methods for measuring the toxicity and bioaccumulation of sediment-associated contaminants with freshwater Invertebrates. 2nd edition. Office of Research and Development, U.S. Environmental Protection Agency Report EPA 600/R-94/064, Duluth, MN, USA.

APPENDIX 7. PROTOCOL FOR WHOLE-SEDIMENT ACUTE POLYCHAETE WORM TOXICITY TESTS USING *AUSTRALONEREIS EHLERSI*

(Prepared by T. Stokie, S. Duda and L. Gunthorpe, May 2004, Primary Industries Research Victoria, Marine and Freshwater Systems, Department of Primary Industries, Queenscliff, VIC)

General disclaimer

This publication may be of assistance to you but the State of Victoria and its employees do not guarantee that the publication is without flaw of any kind or is wholly appropriate for your particular purposes and therefore disclaims all liability for any error, loss or other consequence which may arise from you relying on any information in this publication.

Copyright© The State of Victoria, Department of Primary Industries, 2004. This publication is copyright. No part may be reproduced by any process except in accordance with the provisions of the *Copyright Act 1968*. Authorised by the Victorian Government, Weeroona Parade, Queenscliff 3225

A7.1 Scope and Application

This protocol describes the procedures for testing the toxicity of whole sediments using *Australonereis ehlersi*, a polychaete distributed throughout coastal waters of Australia. The acute lethal toxicity of potentially contaminated sediments is assessed through the percentage survival of adult polychaetes after a 10-day exposure. The protocol is based on the methods developed by Environment Canada (1995, 1997), USEPA (1994) and ASTM (1994, 1995, 1997 and 1999a). Modifications to these test methods were made to accommodate the tolerances and environmental conditions experienced by Australian temperate marine fauna that were validated by Stokie (2000) and Duda (unpublished results).

A7.2 Methods Summary

This toxicity test determines the survival of polychaetes following a 10-d exposure to contaminated sediments from both marine and estuarine environments. Polychaete worms (*Australonereis ehlersi*) are collected from intertidal mud flats and placed in holding tanks with clean control sediment and flow through seawater, prior to their use in tests.

Experiments are conducted in a temperature-controlled room. Overlying water is replaced daily (with minimal disturbance to polychaetes). Aeration is supplied to test beakers at a rate of 3-5 bubbles per second to maintain dissolved oxygen levels above 90% saturation. Airlines are constructed of non-toxic tubing with Pasteur pipettes attached, and are secured with their opening 2-3 cm above the sediment surface to avoid sediment disturbance. Test chambers and airflow are observed daily and any abnormalities noted. Ten polychaetes are placed into each chamber at the start of the test.

Following the 10-d exposure period, sediments are sieved through a 500 µm sieve and castings are gently washed into Petri dishes. Castings are lightly prodded to encourage organisms out of tubes. Results are expressed as % survival. Tests are considered acceptable if survival in the controls was > 80%.

A7.3 Significance and Use

Polychaete worms are an important component of the benthic marine communities in temperate Australia, representing about half of all species of macrobenthic invertebrates present in these environments (Wilson et al., 2003). They play an important role in marine and estuarine food chains occupying several trophic levels (Wilson et al., 2003).

Polychaetes can be useful indicators of pollution as many species have shown to be sensitive to a range of pollutants in particular heavy metals (Ingersoll, 1995; Pocklington and Doe, 1998; Wilson, 2003).

Australonereis ehlersi is endemic to Australia (Dennis (2000). It has a wide salinity tolerance (Stokie and Duda, unpublished data) occurring in marine (Morris, L. pers comm) and estuarine environments, where this species is perhaps the most abundant polychaete (Dennis, 2000; Wilson et al., 2003).

Australonereis ehlersi is widely distributed along the Australian coast, extending across south-eastern and south-western Australia and has been recorded from north-western Australia (Wilson et al., 2003). *Australonereis ehlersi* is present in large densities (Morris, pers comm; Cohen pers comm.; Dennis, 2000) and its abundance shows little seasonality. While this species lives in tubes constructed from sediments, they are deposit feeders and ingest sediment particles. *Australonereis ehlersi* is therefore directly exposed to sediment bound contaminants.

Easy collection, identification (i.e. readily differentiated from other polychaetes) and its minimal maintenance requirements contribute to this species suitability as a test organism. *Australonereis ehlersi* is also sensitive to selected pollutants.

A7.4 Equipment summary

- High density polyethylene buckets, 5 L
- Waders and plastic gloves (for animal collection)
- Stainless steel shovel
- Stainless steel sieves (500 µm)
- Large flat plastic trays (68×40×8.5 cm), for worm collection
- Worm culture tanks – glass tank (60×46×30 cm)
- Wide bore plastic pipette
- Constant temperature testing room with continuous light maintained at 15±1°C.
- Test chambers – 1 L glass beakers

- Air tubing and oil-free compressed air
- Control seawater (filtered to 0.2 µm) and natural filtered seawater (filtered to 0.2 µm)
- DO, pH and salinity meters

A7.5 Procedures

Test materials

Control Sediment

Clean sediments are used as a substrate for laboratory worm cultures, and as controls in the whole sediment assays.

Control sediments are collected from uncontaminated sites with sediments that match the geochemical requirements of the worms (e.g. Edwards Point, Port Phillip Bay Victoria).

Control sediment is collected at low tide. Scrapings of the top 10 cm layer of sediment are collected using a clean stainless steel shovel and placed into clean 5 L high-density polyethylene buckets. On return to the laboratory, control sediments are immediately sieved through a 500 µm sieve to remove all endemic organisms and large debris, which also improves sample homogeneity and counting efficiency (ASTM, 1995; ASTM, 1999a). Sediments are then returned to clean buckets, sealed and maintained at 4°C in the dark for no longer than two weeks before use (ASTM, 1995).

Prior to testing, sediments are removed from the cool room and brought to test temperature (usually overnight).

Sediments must have demonstrated low contaminant levels, and optimal grain size characteristics (<63-500 µm) and porewater salinity (8-40‰) for survival of the worms.

Control seawater

Filtered natural seawater (sand filter, 30 µm) obtained from an uncontaminated site (i.e. near the entrance of Port Phillip Bay) is used to culture and acclimate test organisms.

Natural filtered seawater is further filtered to 0.2 µm, using a CUNO filter system to provide control seawater, which is used in the toxicity tests. The salinity of the control seawater is approx 35‰ and is adjusted using artificial sea salts (Tropic Marine Saltwater®) and/or reverse osmosis water to achieve high or lower salinities respectively.

Control seawater is used as overlying water in whole-sediment tests, and to prepare toxicant solutions.

Test sediment

Approximately 3 kg of test sediment is required. Test sediment is collected by scraping off the top 10 cm layer with a clean shovel. Sediment is placed into a clean, polyethylene container, sealed and transported to the laboratory where it is stored at 4°C in darkness prior to testing. Storage time should not exceed 8 weeks as recommended by Environment Canada (1995).

Prior to testing, test sediments are wet sieved through a 500 µm sieve. Sieved sediments are then placed into clean buckets and brought to test temperature (usually overnight).

A7.6 Collection, Handling and Culturing of Worms

Worms (*A. ehlersi*) are collected from wild populations located on intertidal mudflats at Werribee, west of Melbourne on the shores of Port Phillip Bay. Using a shovel, scrapings of the top 10 cm layer of sediment are taken and sieved on site through a 500 µm mesh. Worm castings retained on the sieve are washed into a polyethylene bucket, which is sealed and transported to the laboratory. The castings are then placed in sorting trays, in approximately 1 cm of clean seawater, until the worms emerge (usually within 24 h) and swim to the water's surface. The worms are then collected in a small plastic hand pipette and transferred to glass holding tanks (0.5 × 0.6 m) with a flow-through filtered water supply and a 5 cm layer of control sediment. The seawater within the tanks is gently aerated. Holding tanks are monitored daily to ensure a suitable pH,

temperature, salinity, dissolved oxygen level and adequate water circulation is maintained.

Worms are fed twice weekly with ground fish food (Excelpet Goldfish Flakes®) by spreading a thin layer over the sediment surface.

Worms to be used in toxicity tests are obtained from the holding tanks by gently sieving the holding tank sediment through a 500 µm sieve, immediately before the commencement of the toxicity test. If required, worms are then acclimated to the required test temperature by gradually increasing or decreasing the temperature of the natural filtered seawater in the culture tanks.

A7.7 Toxicity Test

The test protocol is summarised in Table A7.

Test setup

Approximately 18 h prior to the day on which the toxicity test commences, sediment samples are removed from cold storage and allowed to acclimate to test temperature (15°C) in the storage container. While within the storage container, any overlying pore water that has separated from the sediment is mixed back using a suitable non-toxic implement. Sediment samples are then wet sieved (500 µm).

A 200 g aliquot of the test sediment is added to each of four replicate 1 L glass beakers. This procedure is repeated for each sediment to be tested including the control sediment. Air bubbles are removed by gently agitating the beakers. Uncontaminated filtered seawater (~700 mL) is then added to each beaker so as to minimise re-suspension of the underlying sediment.

Beakers are covered with cling wrap (Vitafilm® Hunstman Film Products Pty. Ltd.) to avoid evaporation of the seawater, test material and avoid contamination.

The overlying water is continuously aerated with a slow bubbling to maintain ≥90% dissolved oxygen throughout the test. The air-

Table A7. Summary of Test Conditions for the 10-d Acute Sediment Toxicity Test with the Polychaete Worm *Australonereis ehlersi*

Test type	Static non-renewal
Test duration	10 d
Temperature	15±1 °C
Salinity	36 ± 1‰, or as required (acceptable range 8 to 40)
pH	8.0 ± 0.6
Photoperiod	Continuous light
Aeration	1 outlet with slow bubbling to maintain ≥90% dissolved oxygen throughout the test
Test chamber	1 L glass beaker
Sediment weight	200 g
Overlying water volume	~700 mL
Total test volume	900 mL
No. of test organisms / test chamber	10
No. of replicate beakers / sample	4
Feeding regime	None during the test
Control sediment	Uncontaminated sediment with physico-chemical parameters (grain size, salinity and pH) within tolerance range of organism
Overlying water	Uncontaminated seawater filtered to 0.45 µm and adjusted using artificial sea salts (Tropic Marine Saltwater®) and/or reverse osmosis water to achieve high or lower salinities respectively
Sediment sample weight required	3 kg
Reference Toxicant	Copper, water only exposure, duration = 96 h Whole sediment exposure, duration = 10 d
Endpoint	Survival
Test acceptability criteria	≥80% survival in controls, physico-chemical parameters (dissolved oxygen, pH, salinity and temperature) within acceptable limits throughout the test

lines are constructed of non-toxic tubing with Pasteur pipettes attached, and are secured with their opening 2-3 cm above the sediment surface to avoid disturbing the sediment surface.

Test initiation – addition of worms

When sediment has reached the required test temperature, the test commences. Ten worms are placed randomly in each chamber (ASTM, 1999a; ASTM 1999b; USEPA/USACE, 1998). Only actively swimming worms are selected for inclusion in the toxicity test. Worms are obtained using a wide bore plastic pipette and are placed into the overlying water. The beakers are recovered with cling wrap. The beakers are then placed randomly in a constant temperature room at 15°C and the aeration adjusted to maintain ≥90% dissolved

oxygen levels. As polychaetes have no specific light requirements, a continuous light regime is maintained (ASTM, 1999a; ASTM, 1999b).

The worms are not fed during experiments, in accordance with ASTM protocols, as food may alter contaminant bioavailability and interfere with route of contaminant exposure (ASTM, 1999a; ASTM, 1999b).

Test maintenance and termination

The test begins when the worms are added to test chambers.

Each day throughout the test, the test chambers and airflow are observed, and malfunctions corrected and noted. Physico-chemical parameters are measured every third day to ensure conditions are maintained.

Following the 10-day sediment exposure period, the test is completed. Each sediment (including the overlying water) is sieved through a 500 µm sieve and the castings gently washed into a Petri dish. Castings are lightly prodded to encourage the worms to leave the tubes. Moribund worms are gently prodded with a pipette. If no response occurs, these worms are considered to be dead. Any missing animals are also presumed to have died and are recorded as such.

The number of worms alive and dead in each test chamber is recorded and the % survival for each test chamber is calculated.

A7.8 Chemical and Physico-chemical Analyses

The physico-chemical parameters of each test chamber are monitored prior to the commencement of the test and then every third day through the 10-d exposure period. The physico-chemical parameters measured in the overlying water include:

- dissolved oxygen
- pH
- salinity, and
- temperature.

These parameters are monitored to ensure the test conditions remain within the acceptable limits for quality control purposes.

At the completion of the test, sub-samples of the test sediments from each concentration (~10 g) are taken and sent for chemical analyses.

A7.9 Statistical Analyses

Toxicity is expressed as 10-d LC50 value, i.e. the concentration affecting survival of 50% of the organisms. LC50 values are calculated using ToxCalc Version 5.0 (Tidepool Scientific Software). After testing the data for normality and homogeneity of variance, Dunnett's Multiple Comparison Test or the Bonferroni t-test is used to determine which treatments are significantly different from the controls. The

no observable effect concentration (NOEC) is the highest concentration tested at which no statistically significant effect is observed on per cent survival. The lowest observable effect concentration (LOEC) is the lowest concentration tested to cause a statistically significant effect on per cent survival. Tests for significance between single test concentrations and controls are determined using a one-way analysis of variance (ANOVA) or Student's t-test. Significance levels are tested at the ≤ 0.05 level.

A7.10 Quality Control

Test acceptability

Survival in the control is required to be >80% for a test to be acceptable. Control survival reflects the health of test organisms, suitability of handling procedures, test conditions and test methods. If control survival falls below 80%, then factors not controlled-for in the test procedure are affecting survival and the test is considered invalid (Environment Canada, 1995).

In addition, for the test to remain valid, physico-chemical parameters and mandatory test conditions must remain within the specified acceptable limits (Table A7) throughout the test period.

A reference toxicant test should be conducted in parallel to the toxicity test so that an assessment can be made of both the test organisms' condition and the ability of the test to perform within consistent and reproducible limits.

Reference toxicant tests can take the form of a 96-h water-only procedure using a range of toxicant concentrations or a 10-d whole-sediment test using control sediments spiked with a range of toxicant concentrations.

Each of these reference toxicant tests should show reproducible results, and have LC50, NOEC and LOEC values that are consistent and fall within control limits established for the test. At least ten reference toxicant tests should be conducted to establish control limits

set at the mean LC50 \pm 2 SD. A test is considered *unacceptable* if the LC50 value falls outside the 95% confidence limits set.

Reference toxicant test

Copper is the recommended reference toxicant for both water-only and whole-sediment reference toxicant tests.

Water-only reference toxicants tests are conducted without sediment.

Stock solutions (1 g/L) of the reference toxicant copper, are prepared on the day the test commences. Chemicals are weighed using Mettler® NATA certified analytical scales then dissolved into 990 mL seawater with 10 mL concentrated HCl and stored at 4°C.

Working stock solutions, 100 mg/L, are prepared for each experiment by diluting 100 mL of stock solution in 900 mL water. The concentration of hydrochloric acid added to test chambers is minimal and does not alter pH levels and does not affect the behaviour and survival of the test worms.

Water-only tests consist of five toxicant concentrations plus a seawater control. Each concentration has 4 replicates. Concentrations (i.e. 4 replicates) are prepared, from lowest to highest, using a 5-L flat-bottom round flask. The required amount of stock solution for 4 beakers is pipetted into the flask containing 3200 mL test seawater (i.e. 800 mL per beaker), mixed to distribute the toxicant homogeneously throughout the water, and distributed to the four test chambers. Control groups are prepared using the same method to ensure method acceptability (ASTM, 1999a; ASTM, 1999b).

Nominal copper concentrations recommended for water-only reference toxicant tests are 0, 0.05, 0.1, 0.2, 0.4, 0.8 mg/L.

A7.11 References

Adams, M.S., Duda, S., Stokie, T., Stauber J.L., and Gunthorpe, L. (2001). Development of marine whole-sediment toxicity tests. NHT Grant Final

Report. CSIRO Energy Technology Investigation Report, No. ET/IR461, Lucas Heights, NSW, 10pp.

- ASTM (1994). Standard guide for collection, storage, characterisation and manipulation of sediments for toxicological testing, E 1391-94. American Society for Testing and Materials, Philadelphia, PA, USA.
- ASTM (1995). Standard guide for measuring the toxicity of sediment-associated contaminants with fresh water invertebrates, E 1706-95b. American Society for Testing and Materials, Philadelphia, PA, USA.
- ASTM (1997). Standard guide for selection of resident species as test organisms for aquatic and sediment toxicity tests. American Society for Testing and Materials, E 1850-97, Philadelphia, PA, USA.
- ASTM (1999a). Standard guide for conducting 10-day static sediment toxicity tests with the marine and estuarine amphipods, E 1367-99. American Society for Testing and Materials, Philadelphia, PA, USA.
- ASTM (1999b). Standard guide for conducting 10-day static sediment toxicity tests with marine and estuarine amphipods. American Society for Testing and Materials ASTM E 1367-99, Philadelphia, PA, USA.
- Dennis, P. (2000). An ecological synopsis of the benthic invertebrate community of Manly Lagoon. UTS Freshwater Ecology Report, Department of Environmental Sciences, University of Technology, Sydney.
- Environment Canada (1995). Guidance document on measurement of toxicity test precision using control sediment spiked with a reference toxicant. Environment Canada Environmental Protection Series Report EPS 1/RM/30, Ottawa, ON, Canada.
- Environment Canada (1997). Biological Test Method: Test for survival and growth in sediment using the freshwater amphipod *Hyaella azteca*. Environment Canada Report EPS 1/RM/33, Ottawa, ON, Canada.
- Ingersoll, C.G. (1995). Sediment tests. In: Fundamentals of Aquatic Toxicology: Effects, Environmental Fate and Risk Assessment. 2nd edn, Rand, G.M., (editor), Taylor and Francis, USA, pp. 231-255.
- Pocklington, P., and Doe, K.G (1998). Development of a Canadian marine toxicity test for whole sediments using cultured spionid polychaetes. In: Microscale Testing in Aquatic Toxicology, Wells, P.G., Lee, K., and Blaise, C. (editors), CRC Press, Boca Raton, pp. 395-407.
- Stokie, T. (2000). Development of marine whole sediment toxicity tests using the polychaete *Australonereis ehlersi* and amphipod *Corophium insidiosum*. Honours Thesis, University of Melbourne.
- USEPA (1994). Methods for assessing the toxicity of sediment-associated contaminants with estuarine and marine amphipods. U.S. Environmental Protection Agency Report EPA 600/R-94/025, Narragansett, RI. 134 pp.
- USEPA/USACE (1998). Evaluation of dredged material proposed for discharge in waters of the U.S. U.S. Environmental Protection Agency/U.S. Army Corps of Engineers Testing Manual EPA-823-B-98-004, Washington, DC, USA.
- Wilson, R.S., Hutchings, P.A., and Glasby, C.J. (2003). Polychaetes: An Interactive Identification Guide. CSIRO Publishing, Melbourne. Vic.



APPENDIX 8. GLOSSARY OF TERMS AND ACRONYMS

Acute toxicity: Effects resulting from exposure (usually short-term) over a small part of the organism's life span e.g. mortality, enzyme inhibition.

Algae: Comparatively simple chlorophyll bearing plants, most of which are aquatic, and microscopic in size.

Amphipod: A malacostracan crustacean of the order Amphipoda.

Anodic stripping voltammetry: An electroanalytical technique involving preconcentration and stripping of metals at a mercury electrode.

ANOVA: Analysis of variance.

ANZECC: Australian and New Zealand Environment and Conservation Council.

Aquatic ecosystem: Any water environment from small to large, from pond to ocean, in which plants and animals interact with the chemical and physical features of the environment.

ARMCANZ: Agriculture and Resource Management Council of Australia and New Zealand.

AVS: Acid volatile sulfides, the acid-soluble sulfide concentration in an aquatic sediment.

Benthic: Referring to organisms living in or on the sediments of aquatic habitats.

Bioaccumulation: A general term describing a process by which chemical substances are accumulated by aquatic organisms from water directly or through consumption of food containing the chemicals.

Bioassay: a test used to evaluate the relative potency of a chemical by measuring its effect on a living organism relative to a control.

Bioavailable: Able to be taken up by organisms.

Bioconcentration: A process by which there is a net accumulation of a chemical directly from water into aquatic organisms, resulting from simultaneous uptake (e.g. by gill or epithelial tissue) and elimination.

Biodiversity: The variety and variability of living organisms and the ecological complexes in which they occur.

Biomagnification: The result of the processes of bioconcentration and bioaccumulation by which tissue concentrations of bioaccumulated chemicals increase as the chemical passes up through two or more trophic levels. The term implies an efficient transfer of chemicals from food to consumer so that the residue concentrations increase systematically from one trophic level to the next.

Bivalve: A mollusc with a shell in two parts, hinged together.

Chronic toxicity: Effects over a significant portion of the organism's life span, e.g. effects on growth and reproduction.

Community: Assemblage of organisms characterised by a distinctive combination of species occupying a common environment and interacting with one another.

Community composition: All the types of taxa present in a community.

Concentration: The quantifiable amount of a substance in water, food or sediment.

Contaminants: Biological or chemical substances or entities, not normally present in a system, capable of producing an adverse effect in a biological system, seriously injuring structure or function.

Contaminated sediment: A sediment containing chemical substances at concentrations above background concentrations and above the ANZECC/ ARMCANZ guideline values.

Control sediment: A sediment that is sufficiently free of contaminants that it will not cause effects to test organisms. Generally, a control sediment will have similar physico-chemical parameters as the test sediments.

Control: Part of an experimental procedure that is ideally exactly like the treated part except that it is not subject to the test conditions. It is used as a standard of comparison, to check that the outcome of the experiment is a reflection of the test conditions and not of some unknown general factor.

Criteria (water quality): Scientific data evaluated to derive the recommended quality of water for different uses.

Detection limit: Method detection limit is the concentration of a substance that, when processed through the complete analytical method, produces a signal that has a 99% probability of being different from the blank.

DO: Dissolved oxygen.

DOC: Dissolved organic carbon.

DTA: Direct toxicity assessment.

Ecotoxicology: The science dealing with the adverse effects of chemicals, physical agents and natural products on populations and communities of living organisms.

EC50: The toxicant concentration that is expected to cause one or more specified effects in 50% of a group of organisms under specified conditions.

Formulated sediment: An artificial mixture of materials used to mimic the physical components of a natural sediment.

Guideline: Numerical concentration limit or narrative statement to support and maintain a designated water use.

Hardness: A measure of the sum of the concentrations of calcium and magnesium ions in water, both expressed as mg/L calcium carbonate equivalent.

Hypothesis: Supposition drawn from known facts, made as a starting point for further investigation.

IC50: A toxicant concentration that would cause a 50% reduction in a non-quantal measurement such as fecundity or growth.

Index (indices): Composite value(s) that can give a quick ranking to a waterbody or other ecosystem feature, derived via a formula that combines measurements of important ecosystem characteristics; typically used to rank 'health' or naturalness.

Indicator: Measurement parameter or combination of parameters that can be used to assess the quality of water.

Invertebrates: Animals lacking a dorsal column of vertebrae or a notochord.

LC50: A toxicant concentration that is expected to be lethal to 50% of a group of organisms under specified conditions.

Level of protection: The acceptable level of change from a defined reference condition.

Lowest-observable-effect concentration (LOEC): The lowest tested concentration of a material (toxicant) at which organisms were adversely affected compared to control organisms.

Measurement parameter: Any parameter or variable that is measured to find something out about an ecosystem.

No observable effect concentration (NOEC): The highest tested concentration of a material (toxicant) at which organisms were unaffected, as compared to control organisms.

Organism: Any living animal or plant; anything capable of carrying on life processes.

Overlying water: The water above the sediment at a collection site or in a test chamber.

Oxidation: The combination of oxygen with a substance, or the removal of hydrogen from it, or, more generally, any reaction in which an atom loses electrons.

PAHs: Polycyclic aromatic hydrocarbons.

Pesticide: Substance or mixture of substances used to kill unwanted species of plants or animals.

pH: The intensity of the acidic or basic character of a solution, defined as the negative logarithm of the hydrogen ion concentration of a solution.

Phytoplankton: Plants, usually microscopic, floating in aquatic systems.

Polychaete worm: Chiefly marine annelids possessing both sexes and having paired appendages (parapodia) bearing bristles.

Pore water: The water that occupies the space between and surrounds individual sediment particles in an aquatic sediment (often called *interstitial water*).

Producers: Organisms that can build up their body substance from inorganic materials.

QA/QC: Quality assurance/quality control.

Quality assurance (QA): The implementation of checks on the success of quality control (e.g. replicate samples, analysis of samples of known concentration).

Quality control (QC): The implementation of procedures to maximise the integrity of monitoring data (e.g. cleaning procedures, contamination avoidance, sample preservation methods).

Redox: Simultaneous (chemical) reduction and oxidation; reduction is the transfer of electrons to an atom or molecule, whereas oxidation is the removal of electrons from an atom or molecule.

Redox potential: A measure of the oxidation-reduction potential of sediments. Redox potential is often reported as E_h (versus the normal hydrogen electrode).

Reference sediment: A sediment, generally collected near the study site, that is used to assess the affect of sediment and overlying water conditions exclusive of the material(s) (contaminants, toxicants) of interest.

Reference toxicant: A test conducted with a reference chemical (toxicant) to assess the sensitivity of the test organisms.

Reference condition: An environmental quality or condition that is defined from as many similar systems as possible (including historical

data) and used as a benchmark for determining the environmental quality or condition to be achieved and/or maintained in a particular system of equivalent type.

Risk: A statistical concept defined as the expected frequency or probability of undesirable effects resulting from a specified exposure to known or potential environmental concentrations of a material, organism or condition. A material is considered safe if the risks associated with its exposure are judged to be acceptable. Estimates of risk may be expressed in absolute or relative terms. Absolute risk is the excess risk due to exposure. Relative risk is the ratio of the risk in the exposed population to the risk in the unexposed population.

Salinity: The amount of soluble salts in water or soils.

Sediment: Unconsolidated mineral and organic particulate material that has settled to the bottom of aquatic environments.

Solution concentration: Concentration of contaminants in the liquid phase.

Speciation: Measurement of different chemical forms or species of an element in a solution or solid.

Species: Generally regarded as a group of organisms that resemble each other to a greater degree than members of other groups and that form a reproductively isolated group that will not normally breed with members of another group. (Chemical species are differing compounds of an element.)

Species richness: The number of species present (generally applied to a sample or community).

Spiked sediment: A sediment to which a material has been added for experimental purposes.

Statistical power: The ability of a statistical test to detect an effect given that the effect actually exists.

Stressors: The physical, chemical or biological factors that can cause an adverse effect on an

aquatic ecosystem as measured by the condition indicators.

Sub lethal: Involving a stimulus effect below the level that causes death.

Taxon (taxa): Any group of organisms considered sufficiently distinct from other such groups to be treated as a separate unit (e.g. species, genera, families).

Taxa richness: Number of taxa present.

TIE: Toxicity identification and evaluation.

Toxicant: A chemical capable of producing an adverse response (effect) in a biological system, seriously injuring structure or function or producing death. Examples include pesticides, heavy metals and biotoxins.

Toxicity: The inherent potential or capacity of a material to cause adverse effects in a living organism.

Toxicity test: The means by which the toxicity of a chemical or other test material is determined. A toxicity test is used to measure the degree of response produced by exposure to a specific level of stimulus (or concentration of chemical).

Trophic level: A notional stage in the 'food chain' that transfers matter and energy through a community; primary producers, herbivores, carnivores and decomposers each occupy a different trophic level.

Uptake: A process by which materials are absorbed and incorporated into a living organism.

Whole sediment: The sediment and associated pore water that have had minimal disturbance or manipulation.